



**FSP HySpirit 5k
FSP502PV-230H-48
PVInverter User Manual**

Version: 1.0

Table Of Contents

1. Introduction.....	1
2. Important Safety Warning	2
3. Unpacking & Overview.....	4
4. Installation	5
5. Grid (Utility) Connection	7
6. PV Module (DC) Connection	9
7. Battery Connection.....	12
8. Load (AC Output) Connection	13
9. EMS Connection	15
10. Generator connection	15
12. Communication	16
13. Dry Contact Signal.....	17
14. Relay Control Port	19
15. Application with Energy Meter	21
16. Commissioning.....	22
17. Initial Setup	23
18. Operation	35
19. Charging Management.....	45
20. Maintenance & Cleaning	47
21. Trouble Shooting	48
22. Specifications.....	51
23. Parallel Function.....	53

1. Introduction

This hybrid PV inverter can provide power to connected loads by utilizing PV power, utility power and battery power.

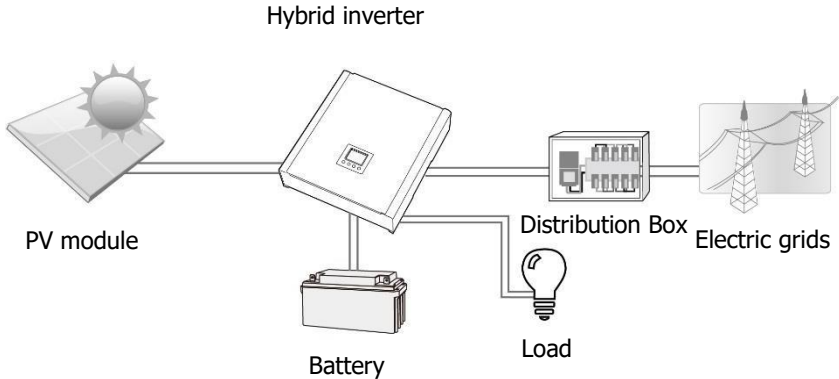

Figure 1 Basic hybrid PV System Overview

Depending on different power situations, this hybrid inverter is designed to generate continuous power from PV solar modules (solar panels), battery, and the utility. When MPP input voltage of PV modules is within acceptable range (see specification for the details), this inverter is able to generate power to feed the grid (utility) and charge battery. This inverter is only compatible with PV module types of single crystalline and poly crystalline. Do not connect any PV array types other than these two types of PV modules to the inverter. Do not connect the positive or negative terminal of the solar panel to the ground. See Figure 1 for a simple diagram of a typical solar system with this hybrid inverter.

Note: By following the EEG standard, every inverter sold to German area is not allowed to charge battery from Utility. The relevant function is automatically disabled by the software.

2. Important Safety Warning

Before using the inverter, please read all instructions and cautionary markings on the unit and this manual. Store the manual where it can be accessed easily.

This manual is for qualified personnel. The tasks described in this manual may be performed by qualified personnel only.

General Precaution-

Conventions used:

WARNING! Warnings identify conditions or practices that could result in personal injury;

CAUTION! Caution identify conditions or practices that could result in damaged to the unit or other equipment connected.



WARNING! Before installing and using this inverter, read all instructions and cautionary markings on the inverter and all appropriate sections of this guide.



WARNING! Normally grounded conductors may be ungrounded and energized when a ground fault is indicated.



WARNING! This inverter is heavy. It should be lifted by at least two persons.



CAUTION! Authorized service personnel should reduce the risk of electrical shock by disconnecting AC, DC and battery power from the inverter before attempting any maintenance or cleaning or working on any circuits connected to the inverter. Turning off controls will not reduce this risk. Internal capacitors can remain charged for 5 minutes after disconnecting all sources of power.



CAUTION! Do not disassemble this inverter yourself. It contains no user-serviceable parts. Attempt to service this inverter yourself may cause a risk of electrical shock or fire and will void the warranty from the manufacturer.



CAUTION! To avoid a risk of fire and electric shock, make sure that existing wiring is in good condition and that the wire is not undersized. Do not operate the Inverter with damaged or substandard wiring.



CAUTION! Under high temperature environment, the cover of this inverter could be hot enough to cause skin burns if accidentally touched. Ensure that this inverter is away from normal traffic areas.



CAUTION! Use only recommended accessories from installer. Otherwise, not-qualified tools may cause a risk of fire, electric shock, or injury to persons.



CAUTION! To reduce risk of fire hazard, do not cover or obstruct the cooling fan.



CAUTION! Do not operate the Inverter if it has received a sharp blow, been dropped, or otherwise damaged in any way. If the Inverter is damaged, please call for an RMA (Return Material Authorization).



CAUTION! AC breaker, DC switch and Battery circuit breaker are used as disconnect devices and these disconnect devices shall be easily accessible.

Before working on this circuit

- Isolate inverter/Uninterruptible Power System (UPS)
- Then check for Hazardous Voltage between all terminals including the protective earth.



Risk of Voltage Backfeed

Symbols used in Equipment Markings

	Refer to the operating instructions
	Caution! Risk of danger
	Caution! Risk of electric shock
	Caution! Risk of electric shock. Energy storage timed discharge for 5 minutes.
	Caution! Hot surface

3. Unpacking & Overview

3-1. Packing List

Before installation, please inspect the unit. Be sure that nothing inside the package is damaged. You should have received the following items inside of package:



Inverter unit



PV connectors

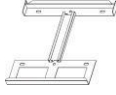

Mounting plate



Fixing screws



EMS port



Software CD



Manual



USB cable



RS-232 cable



Relay control port

3-2. Product Overview

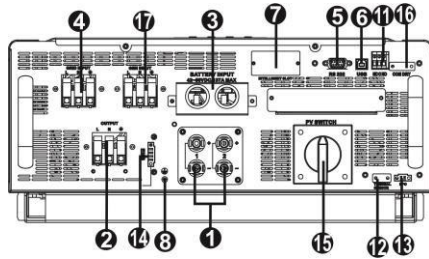
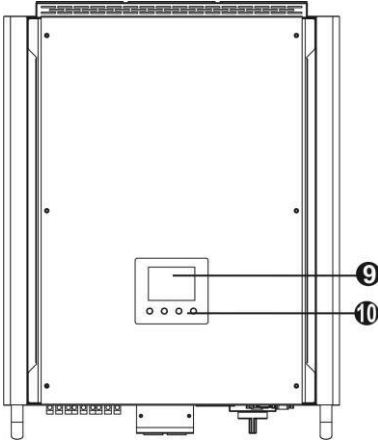

- | | |
|---|-------------------------------|
| 1) PV connectors | 10) Operation buttons |
| 2) AC output connectors (Load connection) | 11) Dry contact |
| 3) Battery connectors | 12) Battery thermal sensor |
| 4) AC Grid connectors | 13) Emergency power off (EPO) |
| 5) RS-232 communication port | 14) EMS port |
| 6) USB communication port | 15) DC Switch |
| 7) Intelligent slot | 16) Relay control port |
| 8) Grounding | 17) Generator connectors |
| 9) LCD display panel (Please check section 10 for detailed LCD operation) | |

4. Installation

4-1. Selecting Mounting Location

Consider the following points before selecting where to install:

- Do not mount the inverter on flammable construction materials.
- Mount on a solid surface
- This inverter can make noises during operation which may be perceived as a nuisance in a living area.
- Install this inverter at eye level in order to allow the LCD display to be read at all times.
- For proper air circulation to dissipate heat, allow a clearance of approx. 20 cm to the side and approx. 50 cm above and below the unit.
- Dusty conditions on the unit may impair the performance of this inverter.
- The ambient temperature should be between 0°C and 40°C and relative humidity should be between 5% and 85% to ensure optimal operation.
- The recommended installation position is to be adhered to vertical.
- For proper operation of this inverter, please use appropriate cables for grid connection.
- The pollution degree of the inverter is PD2. Select an appropriate mounting location. Install the solar inverter in a protected area that is dry, free of excessive dust and has adequate air flow. Do NOT operate it where the temperature and humidity is beyond the specific limits. (Please check the specs for the limitations.)
- Installation position shall not prevent access to the disconnection means.
- This inverter is designed with IP20 for indoor applications only.
- Regularly clean the fan filter.

4-2. Mounting Unit

WARNING!! Remember that this inverter is heavy! Please be carefully when lifting out from the package.

Installation to the wall should be implemented with the proper screws. After that, the device should be bolted on securely.

The inverter only can be used in a CLOSED ELECTRICAL OPERATING AREA. Only service person can enter into this area.

WARNING!! FIRE HAZARD.
SUITABLE FOR MOUNTING ON CONCRETE OR OTHER NON-COMBUSTIBLE SURFACE ONLY.

1. Drill six holes in the marked locations with supplied six screws. The reference tightening torque is 35 N.m.

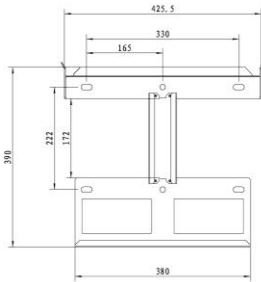

2. Raise the inverter and place it over the mounting plate.

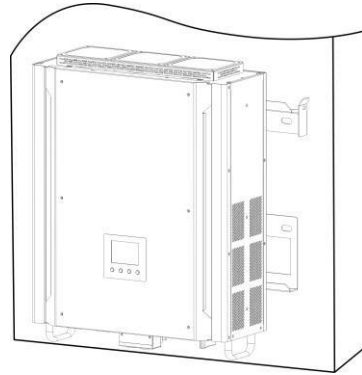

3. Fix the inverter in position by screwing the supplied two screws (M4*12) located on the top two sides of the inverter.

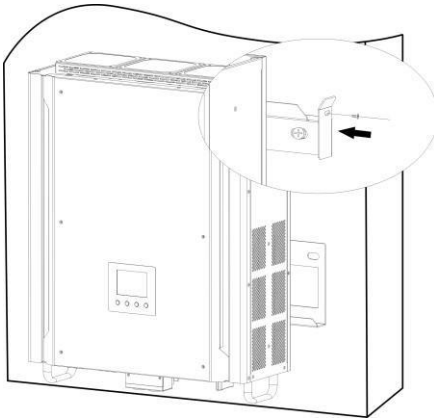

4. Check if the inverter is firmly secured.

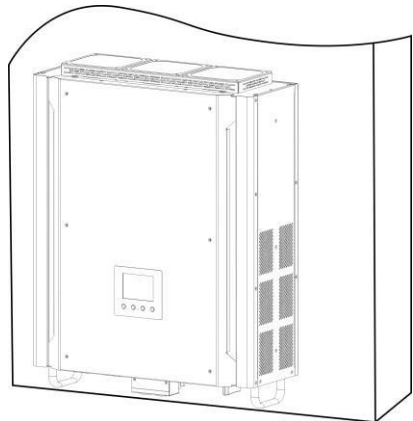

5. Grid (Utility) Connection

5-1. Preparation

Before connecting to AC utility, please install a **separate** AC circuit breaker between inverter and AC utility. This will ensure the inverter can be securely disconnected during maintenance and fully protected from over current of AC input.

NOTE1: Although this inverter is equipped with 250Vac/40A fuse, it's still necessary to install a separate circuit breaker for safety consideration. Please use 250Vac/40A circuit breaker between inverter and AC utility.

NOTE2: The overvoltage category of the AC input is III. It should be connected to the power distribution.

WARNING! It's very important for system safety and efficient operation to use appropriate cable for grid (utility) connection. To reduce risk of injury, please use the proper recommended cable size as below.

Suggested cable requirement for AC wire

Model	5kW
Nominal Grid Voltage	230Vac
Conductor cross-section (mm ²)	6
AWG no.	10

5-2. Connecting to the AC Utility

Step 1: Check the grid voltage and frequency with an AC voltmeter. It should be the same to "Vac" value on the product label.

Step 2: Turn off the circuit breaker.

Step 3: Remove insulation sleeve 10 mm for three conductors. And shorten phase L and neutral conductor N 3 mm. Refer to chart 1.

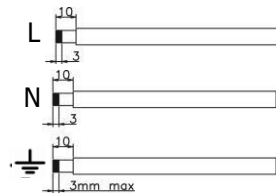

Chart 1

Step 4: Connect wires according to polarities indicated on terminal block. Be sure to connect PE protective conductor (⊕) first.

L → **LINE (brown or black)**

 → **Ground (yellow-green)**

N → **Neutral (blue)**

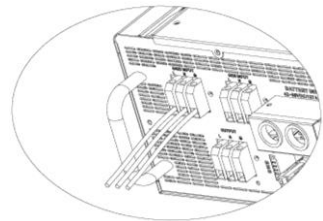

Chart 2

Step 5: Make sure the wires are securely connected.

The reference tightening torque is 0.82 N.m.

5-3. Connecting to the Generator

Step 1: Check the generator voltage and frequency with an AC voltmeter. It should be the same to "Vac" value on the product label.

Step 2: Turn off the circuit breaker.

Step 3: Remove insulation sleeve 10 mm for three conductors. And shorten phase L and neutral conductor N 3 mm. Refer to chart 1.

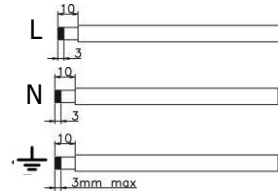



Chart 1

Step 4: Connect wires according to polarities indicated on terminal block. Be sure to connect PE protective conductor (⊕) first.

- L** → **LINE (brown or black)**
-  → **Ground (yellow-green)**
- N** → **Neutral (blue)**

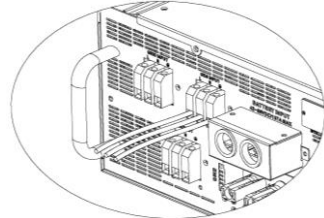

Chart 2

Step 5: Make sure the wires are securely connected. The reference tightening torque is 0.82 N.m.

Note: For safe operation, please use one more wire with ring terminal to connect grounding. Refer to Chart 3.

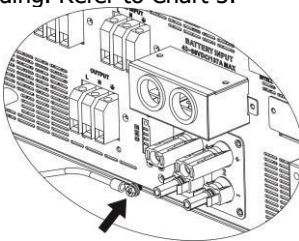
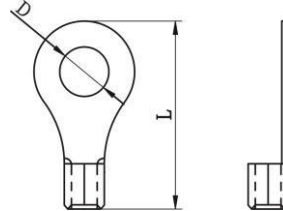

Chart 3

Ring terminal:



Recommended wire and terminal size:

Wire Size	Ring Terminal		Torque value	
	Cable mm ²	Dimensions		
		D (mm)		L (mm)
10 AWG	6	4.3	21.8	1.2~ 2 Nm

CAUTION: To prevent risk of electric shock, ensure the ground wire is properly earthed before operating this hybrid inverter no matter the grid is connected or not.

6. PV Module (DC) Connection

CAUTION: Before connecting to PV modules, please install **separately** a DC circuit breaker between inverter and PV modules.

NOTE1: Please use 1000Vdc/10A circuit breaker.

NOTE2: The overvoltage category of the PV input is II.

Please follow below steps to implement PV module connection:

WARNING: Because this inverter is non-isolated, only three types of PV modules are acceptable: single crystalline and poly crystalline with class A-rated and CIGS modules. To avoid any malfunction, do not connect any PV modules with possibility of leakage current to the inverter. For example, grounded PV modules will cause leakage current to the inverter. When using CIGS modules, please be sure NOT grounding.

CAUTION: It's requested to have PV junction box with surge protection. Otherwise, it will cause inverter damage when lightning occurs on PV modules.

Step 1: Check the input voltage of PV array modules. The acceptable input voltage of the inverter is 250Vdc - 900Vdc. This system is only applied with two strings of PV array. Please make sure that the maximum current load of each PV input connector is 10A.

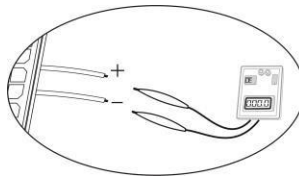

CAUTION: Exceeding the maximum input voltage can destroy the unit!! Check the system before wire connection.

Step 2: Disconnect the circuit breaker and switch off the DC switch.

Step 3: Assemble provided PV connectors with PV modules by the following below steps.

Components for PV connectors and Tools:

Female connector housing	
Female terminal	
Male connector housing	
Male terminal	

Crimping tool and spanner



Cable preparation and connector assembly process:

Strip one cable 8 mm on both end sides and be careful NOT to nick conductors.

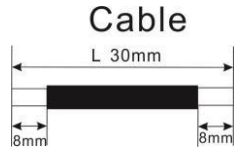

Insert striped cable into female terminal and crimp female terminal as shown below charts.



Insert assembled cable into female connector housing as shown below charts.

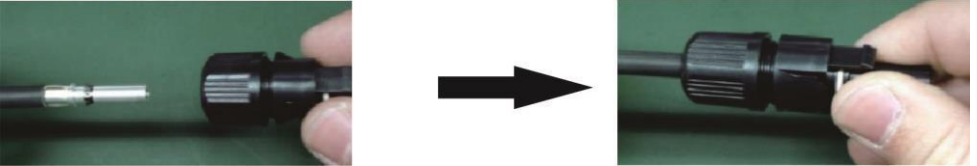

Insert striped cable into male terminal and crimp male terminal as shown below charts.



Insert assembled cable into male connector housing as shown below charts.

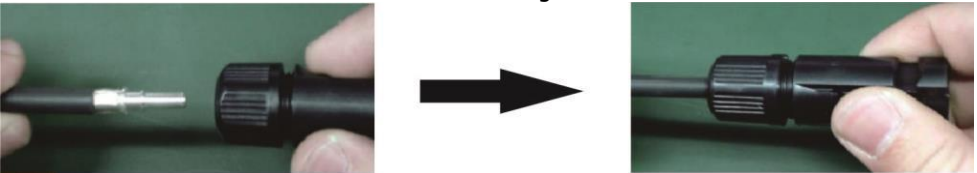

Then, use spanner to screw pressure dome tightly to female connector and male connector as shown below.



Step 4: Check correct polarity of connection cable from PV modules and PV input

connectors. Then, connect positive pole (+) of connection cable to positive pole (+) of PV input connector. Connect negative pole (-) of connection cable to negative pole (-) of PV input connector.

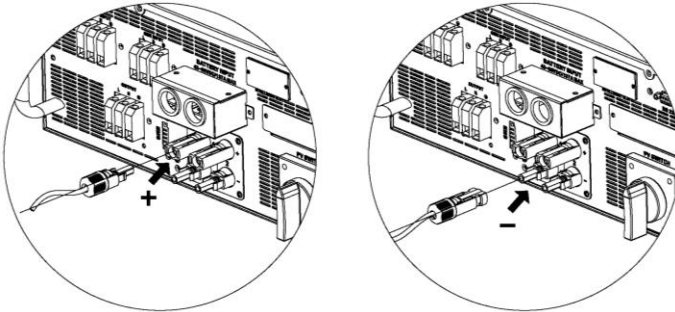

WARNING! It's very important for system safety and efficient operation to use appropriate cable for PV module connection. To reduce risk of injury, please use the proper recommended cable size as below.

Conductor cross-section (mm ²)	AWG no.
4	12

CAUTION: Never directly touch terminals of the inverter. It will cause lethal electric

CAUTION: Do NOT touch the inverter to avoid electric shock. When PV modules are exposed to sunlight, it may generate DC voltage to the inverter.

Recommended Panel Configuration

Solar Panel Spec. (reference)	SOLAR INPUT 1	SOLAR INPUT 2	Q'ty of panels	Total Input Power
	(Min in serial: 11pcs; Max. in serial: 18pcs)			
- 250Wp	11pcs in serial	x	11pcs	2750W
- Vmp: 36.7Vdc	x	11pcs in serial	11pcs	2750W
- Imp: 6.818A	11pcs in serial	11pcs in serial	22pcs	5500W
- Voc: 44Vdc	18pcs in serial	18pcs in serial	36pcs	9000W
- Isc: 7.636A				
- Cells: 72				

7. Battery Connection

CAUTION: Before connecting to batteries, please install **separately** a DC circuit breaker between inverter and batteries.

NOTE1: Please only use sealed lead acid battery, vented and Gel battery. Please check maximum charging voltage and current when first using this inverter. If using Lithium iron or Nicd battery, please consult with installer for the details.

NOTE2: Please use 60Vdc/150A circuit breaker.

NOTE3: The overvoltage category of the battery input is II.

Please follow below steps to implement battery connection:

Step 1: Check the nominal voltage of batteries. The nominal input voltage for inverter is 48Vdc.

Step 2: Use two battery cables. Remove insulation sleeve 12 mm and insert conductor into cable ring terminal. Refer to right chart.

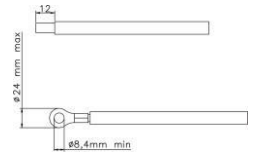

Step 3: Remove battery cover and follow battery polarity guide printed near the battery terminal! Place the external battery cable ring terminal over the battery terminal.

RED cable to the positive terminal (+);
BLACK cable to the negative terminal (-).

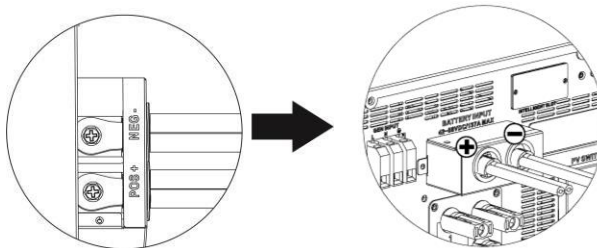

WARNING! Wrong connections will damage the unit permanently.

Step 4: Make sure the wires are securely connected. The reference tightening torque is 2.04 N.m.

WARNING! It's very important for system safety and efficient operation to use appropriate cable for battery connection. To reduce risk of injury, please use the proper recommended cable size as below.

Nominal Battery Voltage	48V
Conductor cross-section (mm ²)	38
AWG no.	2

8. Load (AC Output) Connection

CAUTION: To prevent further supply to the load via the inverter during any mode of operation, an additional disconnection device should be placed on in the building wiring installation.

WARNING! It's very important for system safety and efficient operation to use appropriate cable for AC connection. To reduce risk of injury, please use the proper recommended cable size as below.

Model	5kW
Nominal Grid Voltage	230Vac
Conductor cross-section (mm ²)	6
AWG no.	10

Step 1: Remove insulation sleeve 8 mm for three conductors. And shorten phase L and neutral conductor N 3 mm. Refer to chart 4.

Step 2: Connect wires according to polarities indicated on terminal block. Be sure to connect PE protective conductor (≡) first. Refer to Chart 5.

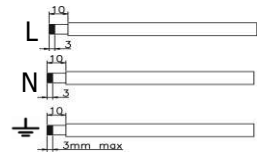

Chart 4

L → **LINE (brown or black)**
≡ → **Ground (yellow-green)**
N → **Neutral (blue)**

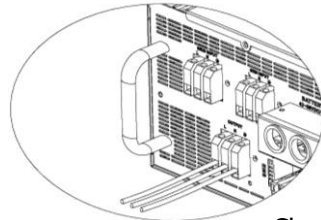

Chart 5

Step 3: Make sure the wires are securely connected.

The reference tightening torque is 0.82 N.m.

CAUTION: It's only allowed to connect load to "AC Output Connector". Do NOT connect the utility to "AC Output Connector".

CAUTION: Be sure to connect L terminal of load to L terminal of "AC Output Connector" and N terminal of load to N terminal of "AC Output Connector". The G terminal of "AC Output Connector" is connected to grounding of the load. Do NOT mis-connect.

Software Setting

Please set up mains output in parameter setting of bundled software. When “Emergency power supply control” is enabled and inverter is working in battery mode, it will cut off AC output and remain energy through EMS port when battery voltage drops down to the setting value in “Battery voltage to cut-off mains output in battery mode”. After that, if battery voltage recovers to the setting value in “Battery voltage to turn on mains output in battery mode”, inverter will turn on AC output again.

Parameters setting

Min. grid-connected voltage: 184 V <input type="button" value="Apply"/>	The waiting time before grid-connection: 60 Sec. <input type="button" value="Apply"/>
Max. grid-connected voltage: 264.6 V <input type="button" value="Apply"/>	Max. grid-connected average voltage: 253 V <input type="button" value="Apply"/>
Min. grid-connected frequency: 47.48 Hz <input type="button" value="Apply"/>	Max. feed-in grid power: 5,000 W <input type="button" value="Apply"/>
Max. grid-connected frequency: 51.6 Hz <input type="button" value="Apply"/>	Feed-in power factor: 1 <input type="button" value="Apply"/>

Min. PV input voltage: 200 V <input type="button" value="Apply"/>	Floating charging voltage: 54 V <input type="button" value="Apply"/>
Max. PV input voltage: 900 V <input type="button" value="Apply"/>	Battery cut-off discharging voltage when Grid is available: 48 V <input type="button" value="Apply"/>
Min. MPP voltage: 250 V <input type="button" value="Apply"/>	Battery re-discharging voltage when Grid is available: 54 V <input type="button" value="Apply"/>
Max. MPP voltage: 850 V <input type="button" value="Apply"/>	Battery cut-off discharging voltage when Grid is unavailable: 42 V <input type="button" value="Apply"/>
Max. charging current: 60 A <input type="button" value="Apply"/>	Battery re-discharging voltage when Grid is unavailable: 48 V <input type="button" value="Apply"/>
Max. AC charging current: 60 A <input type="button" value="Apply"/>	Battery temperature compensation: 0 mV <input type="button" value="Apply"/>
Bulk charging voltage(C.V. voltage): 56 V <input type="button" value="Apply"/>	Max. battery discharge current in hybrid mode: 150 A <input type="button" value="Apply"/>
Start LCD screen-saver after: 60 Sec. <input type="button" value="Apply"/>	Feeding grid power calibration: 0 W <input type="button" value="Apply"/>

Mute Buzzer alarm: <input type="radio"/> Enable <input checked="" type="radio"/> Disable <input type="button" value="Apply"/>	Generator as AC source: <input type="radio"/> Enable <input checked="" type="radio"/> Disable <input type="button" value="Apply"/>
Mute the buzzer in the Standby mode: <input type="radio"/> Enable <input checked="" type="radio"/> Disable <input type="button" value="Apply"/>	Wide AC input range: <input type="radio"/> Enable <input checked="" type="radio"/> Disable <input type="button" value="Apply"/>
Mute alarm in battery mode: <input type="radio"/> Enable <input checked="" type="radio"/> Disable <input type="button" value="Apply"/>	Parallel for output: <input type="radio"/> Enable <input checked="" type="radio"/> Disable <input type="button" value="Apply"/>
Activate Li-Fe battery while commissioning: <input type="radio"/> Yes <input checked="" type="radio"/> No <input type="button" value="Apply"/>	

Emergency power supply control

Battery voltage to cut-off mains output in battery mode: 42 V <input type="radio"/> Enable <input checked="" type="radio"/> Disable <input type="button" value="Apply"/>
Battery voltage to turn on mains output in battery mode: 48 V

9. EMS Connection

This port is available to provide a power source (230V/5A) for emergent light and load.

9-1 Interface Configuration

There are four pins on this port. However, only Pin 1 (Line) and Pin 4 (Neutral) are worktable. Please use supplied cables to connect Pin 1 and Pin 4 shown as below charts.

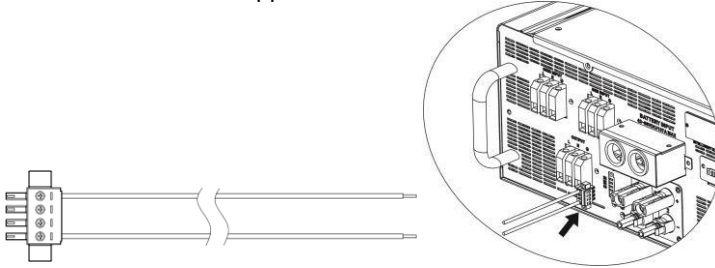

9-2. Function Description

When "Emergency power supply control" is enabled, EMS port will be active. Even though battery voltage drops to cut-off AC output point, EMS port will remain output power for emergent use.

10. Generator connection

It is to connect to generator for power backup when utility is not available and battery is connected. Inverter will trigger generator upon receiving signal from dry contact during low battery.

When generator is triggered, solar power will only charge battery and overload protection will be automatically enabled.

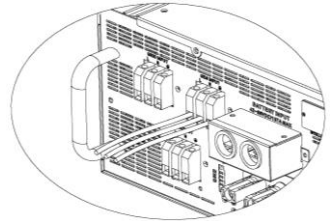

12. Communication

The inverter is equipped with several communication ports and it is also equipped with a slot for alternative communication interfaces in order to communicate with a PC with corresponding software. This intelligent slot is suitable to install with SNMP card and Modbus card. Follow below procedure to connect communication wiring and install the software.

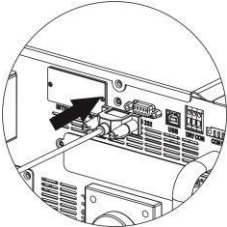
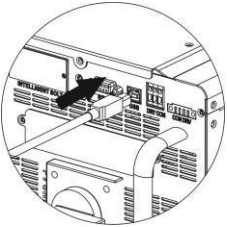
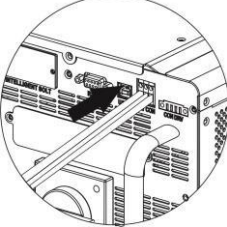
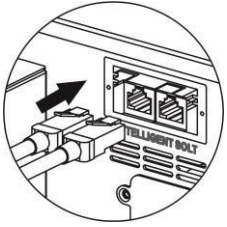
<p>For RS232 port, you should use a DB9 cable as follows:</p>	<p>For USB port, you should use a USB cable as follows:</p>
	
<p>For Dry contact port, please remove insulation sleeve 8 mm for three conductors and insert three cables into ports</p>	<p>For SNMP or MODBUS card, you should use RJ45 cables as follows:</p>
	

Please install monitoring software in your computer. Detailed information is listed in the next chapter. After software is installed, you may initial the monitoring software and extract data through communication port.

13. Dry Contact Signal

There is one dry contact available on the bottom panel. It could be used to remote control for external generator.

12-1. Electric Parameter

Parameter	Symbol	Max.	Unit
Relay DC voltage	Vdc	30	V
Relay DC current	Idc	1	A

Note: The application of the dry contact should not exceed the electric parameter shown as above. Otherwise, the internal relay will be damaged.

12-2. Function Description

Unit Status	Condition	Dry contact port: 	
		NO&C	NC&C
Power Off	Unit is off and no output is powered.	Open	Close
Power On	Battery voltage is lower than setting battery cut-off discharging voltage when grid is available.	Close	Open
	Battery voltage is lower than setting battery cut-off discharging voltage when grid is unavailable.	Close	Open
	Battery voltage is higher than below 2 setting values: 1. Battery re-discharging voltage when grid is available. 2. Battery re-discharging voltage when grid unavailable.	Open	Close

You can set the related parameters in software. Refer to below chart:

The screenshot displays a 'Parameters setting' window with the following parameters and values:

Parameter	Value	Unit	Action
Min. grid-connected voltage:	184	V	Apply
Max. grid-connected voltage:	264.5	V	Apply
Min. grid-connected frequency:	47.48	Hz	Apply
Max. grid-connected frequency:	51.5	Hz	Apply
The waiting time before grid-connection:	60	Sec.	Apply
Max. grid-connected average voltage:	253	V	Apply
Max. feed-in grid power:	5,000	W	Apply
Feed-in power factor:	1		Apply
Min. PV input voltage:	200	V	Apply
Max. PV input voltage:	900	V	Apply
Min. MPP voltage:	250	V	Apply
Max. MPP voltage:	850	V	Apply
Max. charging current:	60	A	Apply
Max. AC charging current:	60	A	Apply
Bulk charging voltage(C.V. voltage):	56	V	Apply
Start LCD screen-saver after:	60	Sec.	Apply
Floating charging voltage:	54	V	Apply
Battery cut-off discharging voltage when Grid is available:	48	V	Apply
Battery re-discharging voltage when Grid is available:	54	V	Apply
Battery cut-off discharging voltage when Grid is unavailable:	42	V	Apply
Battery re-discharging voltage when Grid is unavailable:	48	V	Apply
Battery temperature compensation:	0	mV	Apply
Max. battery discharge current in hybrid mode:	150	A	Apply
Feeding grid power calibration:	0	W	Apply
Mute Buzzer alarm:	Disable		Apply
Generator as AC source:	Disable		Apply
Mute the buzzer in the Standby mode:	Disable		Apply
Wide AC input range:	Disable		Apply
Mute alarm in battery mode:	Disable		Apply
Parallel for output:	Disable		Apply
Activate Li-Fe battery while commissioning:	No		Apply
Emergency power supply control			
Battery voltage of cut-off Main output in battery mode	42	V	Enable/Disable (Disable selected)
Battery voltage of re-connecting Main output in battery mode	48	V	

14. Relay Control Port

This port is available to provide a power source (230V/8A) to trigger external relay. This function is only valid for **Grid-tie with backup II** mode.

13-1. Interface Configuration

There are four pins on this port. However, only Pin 1 and Pin 4 are worktable. Please use supplied cables to connect Pin 1 and Pin 4 shown as below charts.

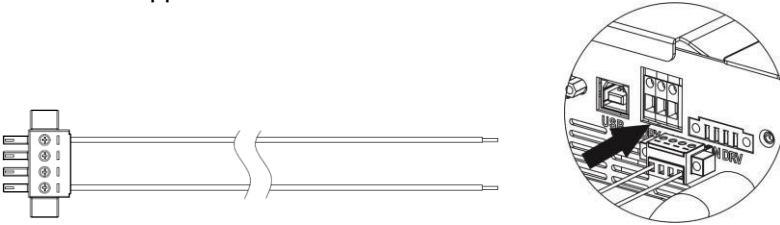

13-2. Function Description

Unit status	Condition	Output voltage from relay control port
Power Off	Unit is off and no output is powered.	0V
Power On	<p>When the unit is working at inverter mode and grid is not available.</p> <p>Condition 1:</p> <p>Condition 2:</p>	230V

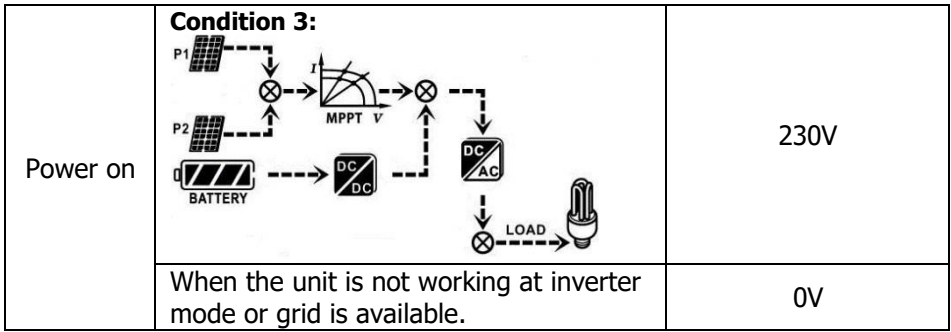

13-3. Application

Below chart is recommended circuit wiring.

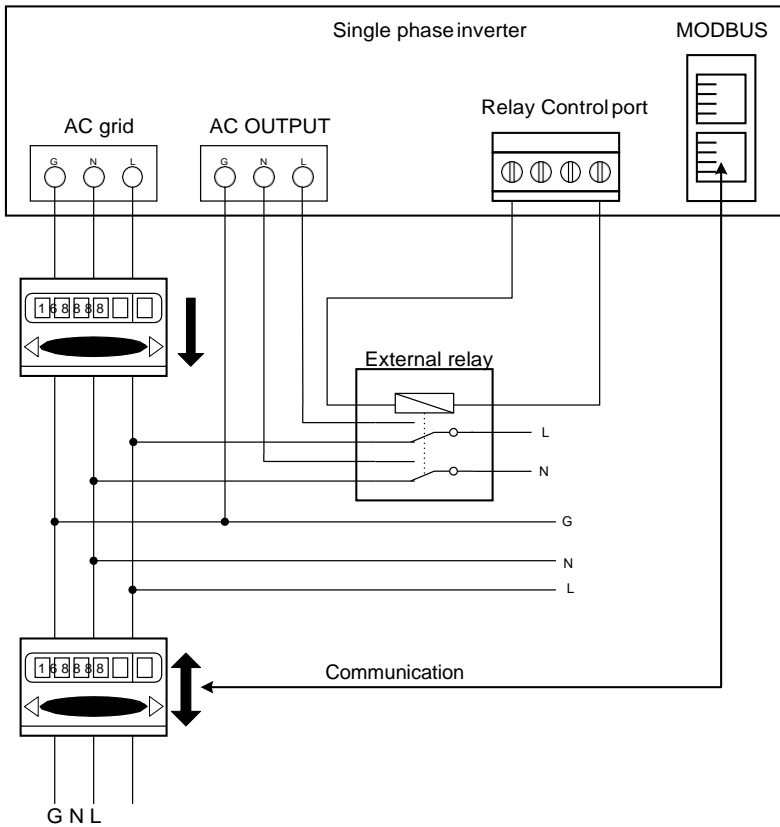

15. Application with Energy Meter

With Modbus card II and energy meter, hybrid inverter can be easily integrated into the existing household system. For details please refer to Modbus card II manual.

Note: this application is only valid for **Grid-Tie with Backup II** mode.

Equipped with Modbus card II, hybrid inverter is connected to energy meter with RS485 communication port. It's to arrange self-consumption via Modbus card to control power generation and battery charging of the inverter.

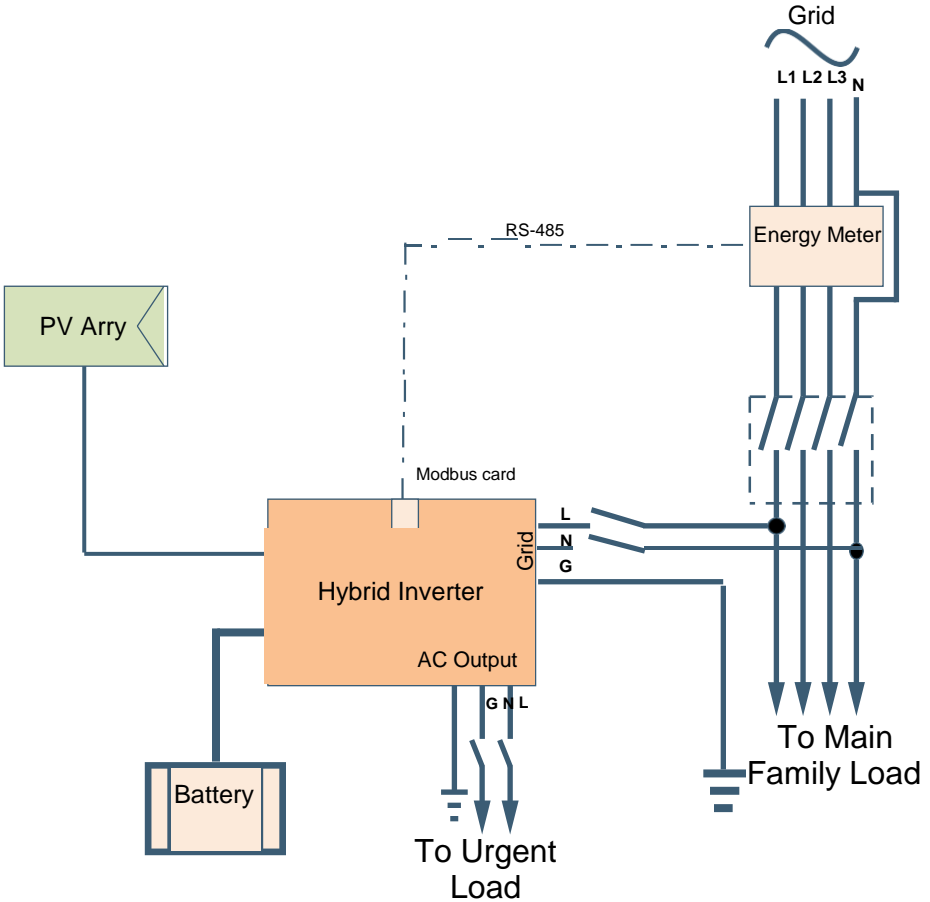

16. Commissioning

Step 1: Check the following requirements before commissioning:

- Ensure the inverter is firmly secured
- Check if the open circuit DC voltage of PV module meets requirement (Refer to Section 6)
- Check if the open circuit utility voltage of the utility is at approximately same to the nominal expected value from local utility company.
- Check if connection of AC cable to grid (utility) is correct if the utility is required.
- Full connection to PV modules.
- AC circuit breaker (only applied when the utility is required), batter circuit breaker, and DC circuit breaker are installed correctly.

Step 2: Switch on the battery circuit breaker and then switch on PV DC breaker. After that, if there is utility connection, please switch on the AC circuit breaker. At this moment, the inverter is turned on already. However, there is no output generation for loads. Then:

- If LCD lights up to display the current inverter status, commissioning has been successfully. After pressing "ON" button for 1 second when the utility is detected, this inverter will start to supply power to the loads. If no utility exists, simply press "ON" button for 3 seconds. Then, this inverter will start to supply power to the loads.
- If a warning/fault indicator appears in LCD, an error has occurred to this inverter. Please inform your installer.

Step 3: Please insert CD into your computer and install monitoring software in your PC. Follow below steps to install software.

1. Follow the on-screen instructions to install the software.
2. When your computer restarts, the monitoring software will appear as shortcut icon located in the system tray, near the clock.

NOTE: If using modbus card as communication interface, please install bundled software. Check local dealer for the details.

17. Initial Setup

Before inverter operation, it's required to set up "Operation Mode" via software. Please strictly follow below steps to set up. For more details, please check software manual.

Step 1: After turning on the inverter and installing the software, please click "Open Monitor" to enter main screen of this software.

Step 2: Log in into software first by entering default password "administrator".

Step 3: Select Device Control>>MyPower Management. It is to set up inverter operation mode and personalized interface. Refer to diagram below.

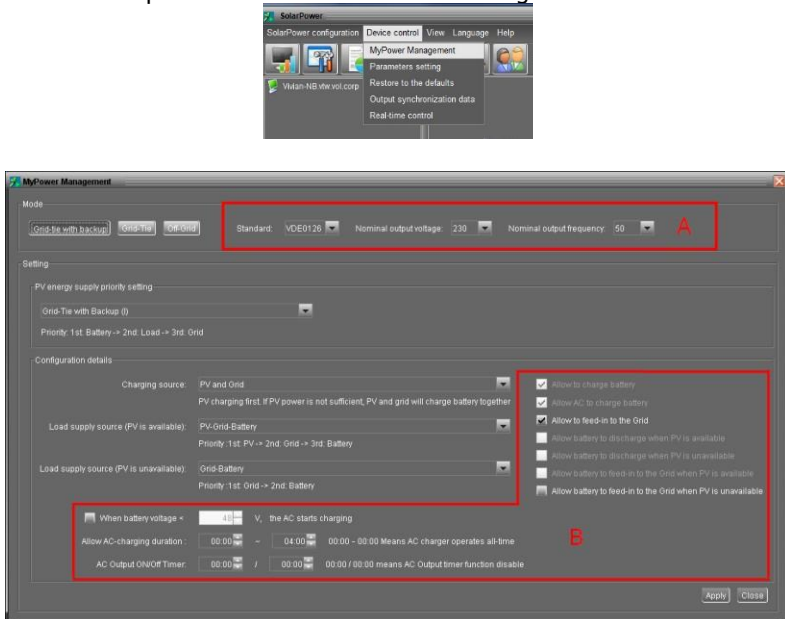

Mode

There are three operation modes: Grid-tie with backup, Grid-Tie and Off-Grid.

- Grid-tie with backup: PV power can feed-in back to grid, provide power to the load and charge battery. There are four options available in this mode: Grid-tie with backup I, II, III and IV. In this mode, users can configure PV power supply priority, charging source priority and load supply source priority. However, when Grid-tie with backup IV option is selected in PV energy supply priority, the inverter is only operated between two working logics based on defined peak time and off-peak time of electricity. Only peak time and off-peak time of electricity are able to set up for optimized electricity usage.
- Grid-Tie: PV power only can feed-in back to grid.
- Off-Grid: PV power only provides power to the load and charge battery. No feed-in back to grid is allowed.

SECTION A:

Standard: It will list local grid standard. It's requested to have factory password to make any modifications. Please check local dealer only when this standard change is requested.

CAUTION: Wrong setting could cause the unit damage or not working.

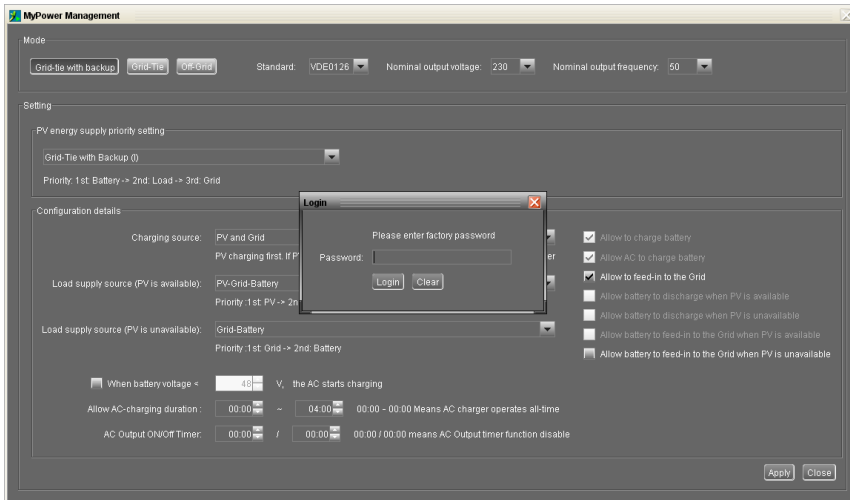

Nominal Output Voltage: 230V.

Nominal Output Frequency: 50HZ.

SECTION B:

This section contents may be different based on different selected types of operations.

Allow AC charging duration: It's a period time to allow AC (grid) to charge battery. When the duration is set up as 0:00-00:00, it means no time limitation for AC to charge battery.

AC output ON/Off Timer: Set up on/off time for AC output of inverter. If setting it as 00:00/00:00, this function is disabled.

Allow to charge battery: This option is automatically determined by setting in "Charging source". It's not allowed to modify here. When "NONE" is selected in charging source section, this option becomes unchecked as grey text.

Allow AC to charge battery: This option is automatically determined by setting in "Charging source". It's not allowed to modify here. When "Grid and PV" or "Grid or PV" is selected in charging source section, this option is default selected. Under Grid-tie mode, this option is invalid.

Allow to feed-in to the Grid: This option is only valid under Grid-tie and Grid-tie with backup modes. Users can decide if this inverter can feed-in to the grid.

Allow battery to discharge when PV is available: This option is automatically determined by setting in "Load supply source (PV is available)". When "Battery" is higher priority than "Grid" in Load supply source (PV is available), this option is default selected. Under Grid-tie, this option is invalid.

Allow battery to discharge when PV is unavailable: This option is automatically determined by setting in "Load supply source (PV is unavailable)". When "Battery" is higher priority than "Grid" in Load supply source (PV is unavailable), this option is default selected. Under Grid-tie mode, this option is invalid.

Allow battery to feed-in to the Grid when PV is available: This option is only valid in Grid-tie with backup II or Grid-tie with backup III modes.

Allow battery to feed-in to the Grid when PV is unavailable: This option is only valid in all options of Grid-tie with backup mode.

Grid-tie with backup

● Grid-tie with backup (I) :

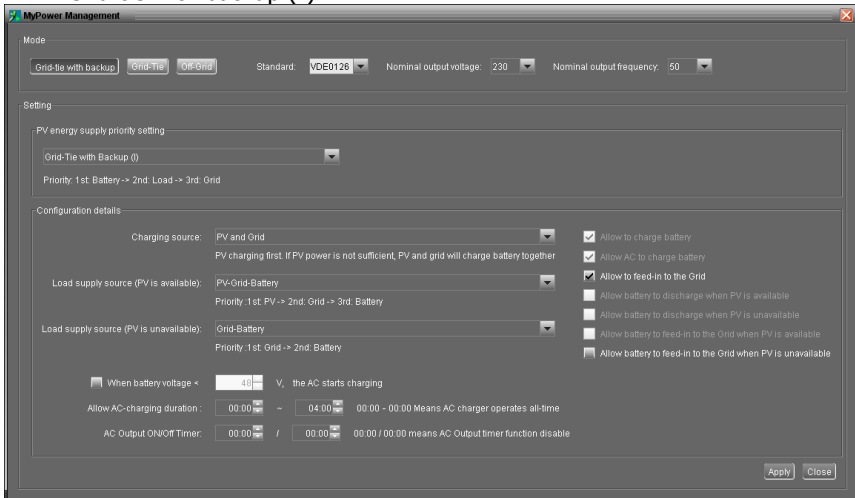

PV energy supply priority setting: 1st Battery, 2nd Load and 3rd Grid.

PV power will charge battery first, then provide power to the load. If there is any remaining power left, it will feed-in to the grid.

Battery charging source:

1. PV and Grid (Default)

It's allowed to charge battery from PV power first. If it's not sufficient, grid will charge

battery.

2. PV only

It is only allow PV power to charge battery.

3. None

It is not allowed to charge battery no matter it's from PV power or grid.

Load supply source:

When PV power is available: 1st PV, 2nd Grid, 3rd Battery

If battery is not fully charged, PV power will charge battery first. And remaining PV power will provide power to the load. If it's not sufficient, grid will provide power to the load. If grid is not available at the same time, battery power will back up.

When PV power is not available:

1. 1st Grid, 2nd Battery(Default)

Grid will provide power to the load at first. If grid is not available, battery power will provide power backup.

2. 1st Battery, 2nd Grid

Battery power will provide power to the load at first. If battery power is running out, grid will back up the load.

NOTE: This option will become ineffective during AC charging time and the priority will automatically become 1st Grid and 2nd Battery order. Otherwise, it will cause battery damage.

● Grid-tie with backup (II) :

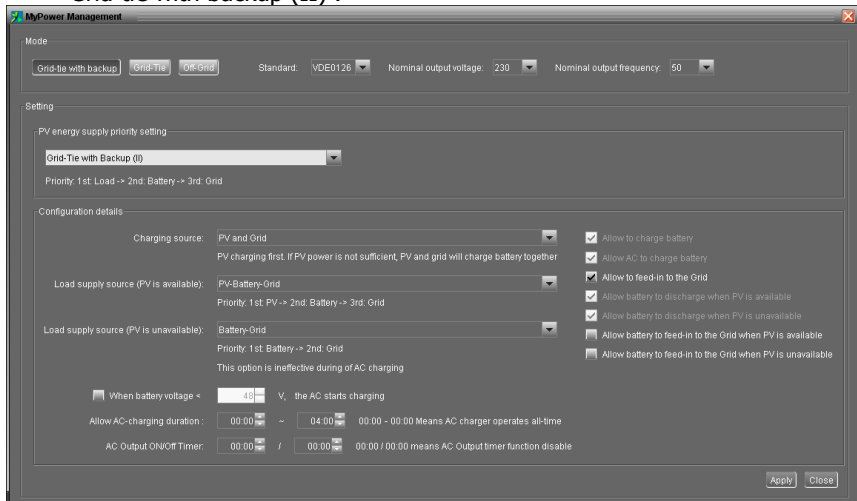

PV energy supply priority setting: 1st Load, 2nd Battery and 3rd Grid.

PV power will provide power to the load first. Then, it will charge battery. If there is any remaining power left, it will feed-in to the grid.

Battery charging source:

1. PV and Grid

It's allowed to charge battery from PV power first. If it's not sufficient, grid will charge battery.

2. PV only

It is only allow PV power to charge battery.

3. None

It is not allowed to charge battery no matter it's PV power or grid.

Load supply source:

When PV power is available:

1. 1st PV, 2nd Battery, 3rd Grid

PV power will provide power to the load first. If it's not sufficient, battery power will provide power to the load. When battery power is running out or not available, grid will back up the load.

2. 1st PV, 2nd Grid, 3rd Battery

PV power will provide power to the load first. If it's not sufficient, grid will provide power to the load. If grid is not available at the same time, battery power will back up.

When PV power is not available:

1. 1st Grid, 2nd Battery: Grid will provide power to the load at first. If grid is not available, battery power will provide power backup.

2. 1st Battery, 2nd Grid: Battery power will provide power to the load at first. If battery power is running out, grid will back up the load

NOTE: This option will become ineffective during AC charging time and the priority will automatically become 1st Grid and 2nd Battery order. Otherwise, it will cause battery damage.

● Grid-tie with backup (III):

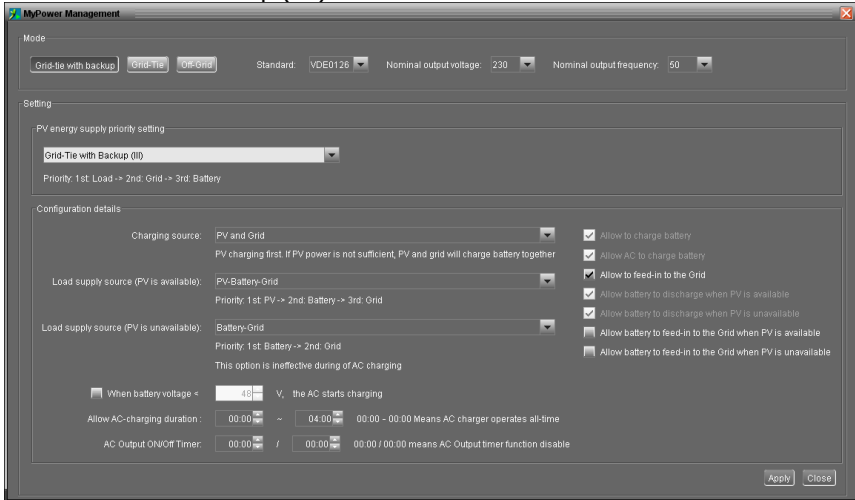

PV energy supply priority setting: 1st Load, 2nd Grid and 3rd Battery

PV power will provide power to the load first. If there is more PV power available, it will feed-in to the grid. If feed-in power reaches max. feed-in power setting, the remaining power will charge battery.

NOTE: The max. feed-in grid power setting is available in parameter setting. Please refer to software manual.

Battery charging source:

1. PV and Grid: It's allowed to charge battery from PV power first. If it's not sufficient, grid will charge battery.
2. PV only: It is only allow PV power to charge battery.
3. None: It is not allowed to charge battery no matter it's PV power or grid.

Load supply source:

When PV power is available:

1. 1st PV, 2nd Battery, 3rd Grid

PV power will provide power to the load first. If it's not sufficient, battery power will provide power to the load. When battery power is running out or not available, grid will back up the load.

2. 1st PV, 2nd Grid, 3rd Battery

PV power will provide power to the load first. If it's not sufficient, grid will provide power to the load. If grid is not available at the same time, battery power will back up.

When PV power is not available:

1. 1st Grid, 2nd Battery: Grid will provide power to the load at first. If grid is not available, battery power will provide power backup.
2. 1st Battery, 2nd Grid: Battery power will provide power to the load at first. If

battery power is running out, grid will back up the load.

NOTE: This option will become ineffective during AC charging time and the priority will automatically become 1st Grid and 2nd Battery order. Otherwise, it will cause battery damage.

- Grid-tie with backup (IV): Users are only allowed to set up peak time and off-peak electricity demand.

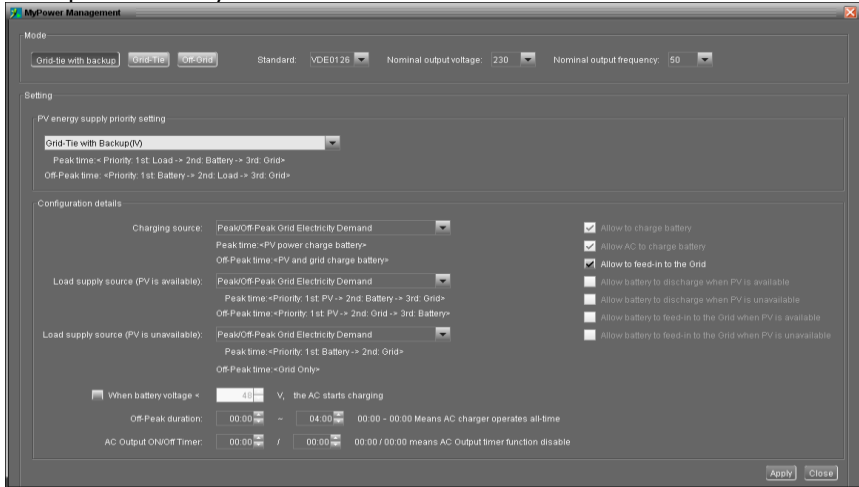

Working logic under peak time:

PV energy supply priority: 1st Load, 2nd Battery and 3rd Grid

PV power will provide power to the load first. If PV power is sufficient, it will charge battery next. If there is remaining PV power left, it will feed-in to the grid. Feed-in to the grid is default disabled.

Battery charging source: PV only

Only after PV power fully supports the load, the remaining PV power is allowed to charge battery during peak time.

Load supply source: 1st PV, 2nd Battery, 3rd Grid

PV power will provide power to the load first. If PV power is not sufficient, battery power will back up the load. If battery power is not available, grid will provide the load. When PV power is not available, battery power will supply the load first. If battery power is running out, grid will back up the load.

Working logic under off-peak time:

PV energy supply priority: 1st Battery, 2nd Load and 3rd Grid

PV power will charge battery first. If PV power is sufficient, it will provide power to the loads. The remaining PV power will feed to the grid.

NOTE: The max. feed-in grid power setting is available in parameter setting.

Please refer to software manual.

Battery charging source: PV and grid charge battery

PV power will charge battery first during off-peak time. If it's not sufficient, grid will charge battery.

Load supply source: 1st PV, 2nd Grid, 3rd Battery

When battery is fully charged, remaining PV power will provide power to the load first. If PV power is not sufficient, grid will back up the load. If grid power is not available, battery power will provide power to the load.

Grid-Tie

Under this operation mode, PV power only feeds-in to the grid. No priority setting is available.

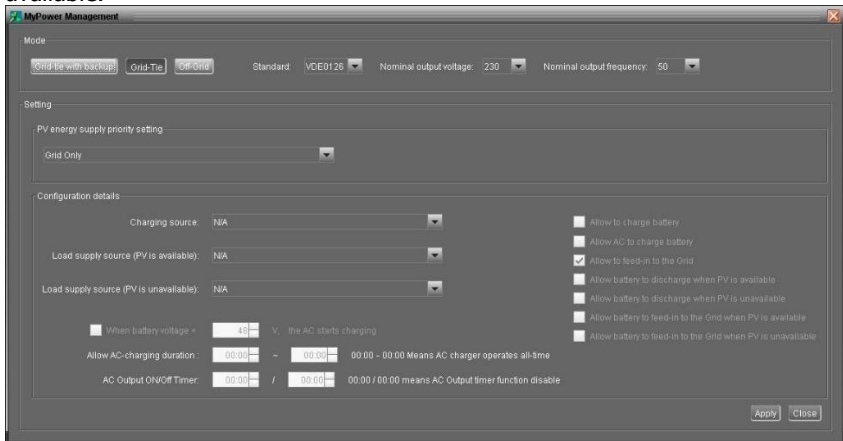

Off-Grid

● Off-Grid (I): Default setting for off-grid mode.

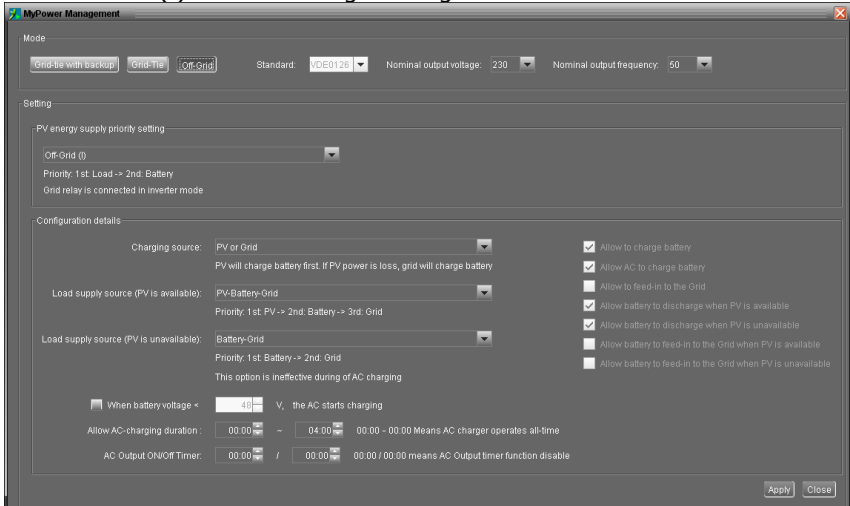

PV energy supply priority setting: 1st Load, 2nd Battery

PV power will provide power to the load first and then charge battery. Feed-in to the grid is not allowed under this mode. At the same time, the grid relay is connected in Inverter mode. That means the transfer time from inverter mode to battery mode will be less than 15ms. Besides, it will avoid overload fault because grid can supply load when connected load is over 5kW.

Battery charging source:

1. PV or Grid: If there is remaining PV power after supporting the loads, it will charge battery first. Only until PV power is not available, grid will charge battery. (Default)
2. PV only: It is only allow PV power to charge battery.
3. None: It is not allowed to charge battery no matter it's PV power or grid.

Load supply source:

When PV power is available:

1. 1st PV, 2nd Battery, 3rd Grid (Default)

PV power will provide power to the load first. If it's not sufficient, battery power will provide power to the load. When battery power is running out or not available, grid will back up the load.

2. 1st PV, 2nd Grid, 3rd Battery

PV power will provide power to the load first. If it's not sufficient, grid will provide power to the load. If grid is not available at the same time, battery power will back up.

When PV power is not available:

1. 1st Grid, 2nd Battery

Grid will provide power to the load at first. If grid is not available, battery power will

provide power backup.

2. 1st Battery, 2nd Grid(Default)

Battery power will provide power to the load at first. If battery power is running out, grid will back up the load.

NOTE: This option will become ineffective during AC charging time and the priority will automatically become 1st Grid and 2nd Battery order. Otherwise, it will cause battery damage.

● Off-Grid (II)

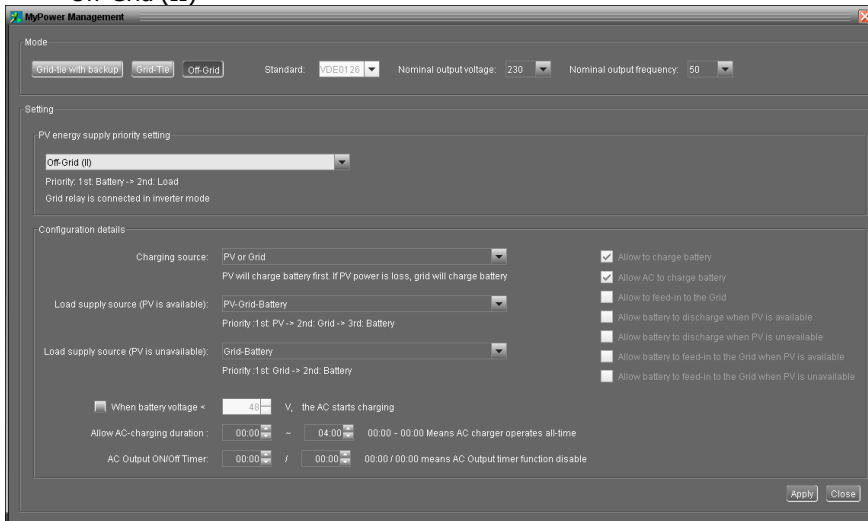

PV energy supply priority setting: 1st Battery, 2nd Load

PV power will charge battery first. After battery is fully charged, if there is remaining PV power left, it will provide power to the load. Feed-in to the grid is not allowed under this mode. At the same time, the grid relay is connected in Inverter mode. That means the transfer time from inverter mode to battery mode will be less than 15ms. Besides, it will avoid overload fault because grid can supply load when connected load is over 5KW.

Battery charging source:

1. PV or Grid: If there is remaining PV power after supporting the loads, it will charge battery first. Only until PV power is not available, grid will charge battery.
2. PV only: It is only allow PV power to charge battery.
3. None: It is not allowed to charge battery no matter it's PV power or grid.

NOTE: It's allowed to set up AC charging duration.

Load supply source:

When PV power is available: 1st PV, 2nd Grid, 3rd Battery

PV power will provide power to the load first. If it's not sufficient, grid will provide power to the load. If grid is not available at the same time, battery power will back up.

When PV power is not available:

1. 1st Grid, 2nd Battery: Grid will provide power to the load at first. If grid is not available, battery power will provide power backup.
2. 1st Battery, 2nd Grid: Battery power will provide power to the load at first. If battery power is running out, grid will back up the load.

NOTE: This option will become ineffective during AC charging time and the priority will automatically become 1st Grid and 2nd Battery order. Otherwise, it will cause battery damage.

● Off-Grid (III)

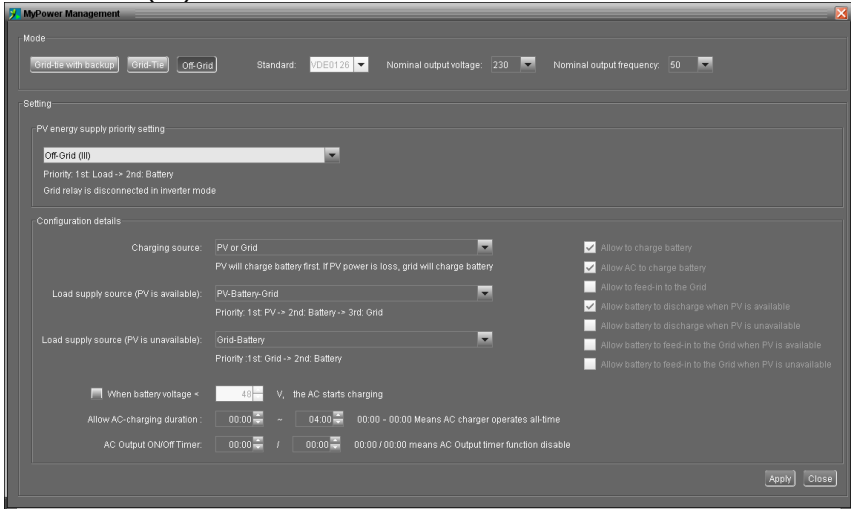

PV energy supply priority setting: 1st Load, 2nd Battery

PV power will provide power to load first and then charge battery. Feed-in to the grid is not allowed under this mode. The grid relay is NOT connected in Inverter mode. That means the transfer time from inverter mode to battery mode will be about 15ms. If connected load is over 5kW and grid is available, this inverter will allow grid to provide power to the loads and PV power to charge battery.

Otherwise, this inverter will activate fault protection.

Battery charging source:

1. PV or Grid: If there is remaining PV power after supporting the loads, it will charge battery first. Only until PV power is not available, grid will charge battery.
2. PV only: It is only allow PV power to charge battery.
3. None: It is not allowed to charge battery no matter it's PV power or grid.

NOTE: It's allowed to set up AC charging duration.

Load supply source:

When PV power is available: 1st PV, 2nd Battery, 3rd Grid

PV power will provide power to the load first. If it's not sufficient, battery power will back up the load. Only after battery power is running, Grid will back up the load.

When PV power is not available:

1. 1st Grid, 2nd Battery: Grid will provide power to the load at first. If grid is not available, battery power will provide power backup.
2. 1st Battery, 2nd Grid: Battery power will provide power to the load at first. If battery power is running out, grid will back up the load.

NOTE: This option will become ineffective during AC charging time and the priority will automatically become 1st Grid and 2nd Battery order. Otherwise, it will cause battery damage.

18. Operation

18-1. Interface



This display is operated by four buttons as shown in the left diagram

NOTICE: To accurately monitor and calculate the energy generation, please calibrate the timer of this unit via software every one month. For the detailed calibration, please check the user manual of bundled software.



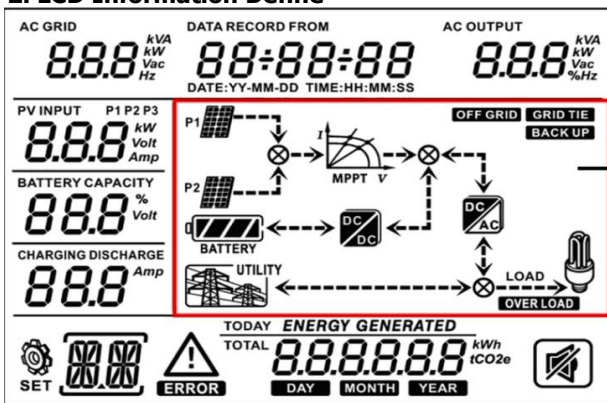









18-2. LCD Information Define



Real-time operation status

Section 18-5 describes all operation conditions when the inverter is set up in "Grid-tie with backup (I)" mode.

Display	Function
AC GRID 8.8.8 ^{Vac} _{Hz}	Indicates AC input voltage or frequency. Vac: voltage, Hz: frequency
AC OUTPUT 8.8.8 ^{kVA} kW Vac %Hz	Indicates AC output power, voltage, frequency, or load percentage. kVA: apparent power, kW: active power, Vac: Voltage, %: Load percentage, Hz: frequency
PV INPUT P1 P2 8.8.8 ^{kW} Volt	Indicates PV input voltage or power. Volt: voltage, kW: power, P1: PV input 1, P2: PV input 2
BATTERY CAPACITY 8.8.8 [%] Volt	Indicates battery voltage or percentage. Volt: voltage, %: percentage
CHARGING DISCHARGE 8.8.8 ^{Amp}	Indicates charging current to battery or discharging current from battery.
	Indicates that the warning occurs.

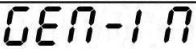
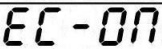
	<p>Indicates that the fault occurs.</p>
	<p>Indicates fault code or warning code.</p>
<p>DATA RECORD FROM  <small>DATE : YY - MM - DD TIME : HH : MM : SS</small></p>	<p>Indicates date and time, or the date and time users set for querying energy generation.</p>
	<p>Indicates solar panels. Icon flashing indicates PV input voltage or is out of range.</p>
	<p>Indicates utility. Icon flashing indicates utility voltage or frequency is out of range.</p>
	<p>Indicates battery condition. And the lattice of the icon indicates battery capacity.</p>
	<p>Icon  flashing indicates battery is not allowed to discharge.</p>
	<p>Icon  flashing indicates the battery voltage is too low.</p>
	<p>Indicates AC output for loads is enabled and inverter is providing power to the connected loads.</p>
	<p>Indicates AC output for loads is enabled but there is no power provided from inverter. At this time, no battery and the utility are available. Only PV power exists but is not able to provide power to the connected loads.</p>
<p>OVER LOAD</p>	<p>Indicates overload.</p>
<p>TODAY ENERGY GENERATED TOTAL  <small>Kwh</small> <small>IC02e</small> <small>DAY MONTH YEAR</small></p>	<p>Indicates PV energy generated.</p>
	<p>Indicates inverter is using generator.</p>
	<p>Indicates inverter is connecting with Energy meter.</p>

18-3. Button Definition

Button	Operation	Function
ENTER/ON	Short press.	Enter query menu.
		If it's in query menu, press this button to confirm selection or entry.
	Press and hold the button for approximately 1 second when the utility is detected or 3 seconds without the utility.	This inverter is able to provide power to connected loads via AC output connector.
ESC/OFF	Short press.	Return to previous menu.
	Press and hold the button until the buzzer continuously sounds.	Turn off power to the loads.
Up	Short press.	Select last selection or increase value.
Down	Short press.	If it's in query menu, press this button to jump to next selection or decrease value.
		Mute alarm in standby mode or battery mode.

NOTE: If backlight shuts off, you may activate it by pressing any button. When an error occurs, the buzzer will continuously sound. You may press any button to mute it.

18-4. Query Menu Operation

The display shows current contents that have been set. The displayed contents can be changed in query menu via button operation. Press 'Enter' button to enter query menu. There are seven query selections:

- Input voltage or frequency of AC input.
- Frequency, voltage, power or load percentage of AC output.
- Input voltage or power of PV input.
- Battery voltage or capability percentage.
- Date and time.
- Today or total energy generated.
- Mode of query energy generated.

Setting Display Procedure

● Input voltage or frequency of AC input

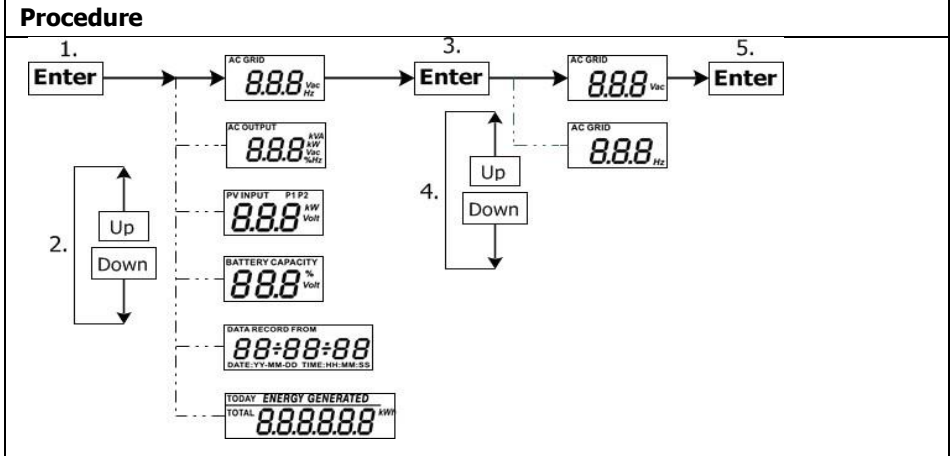

● Frequency, voltage, power or percentage of AC output

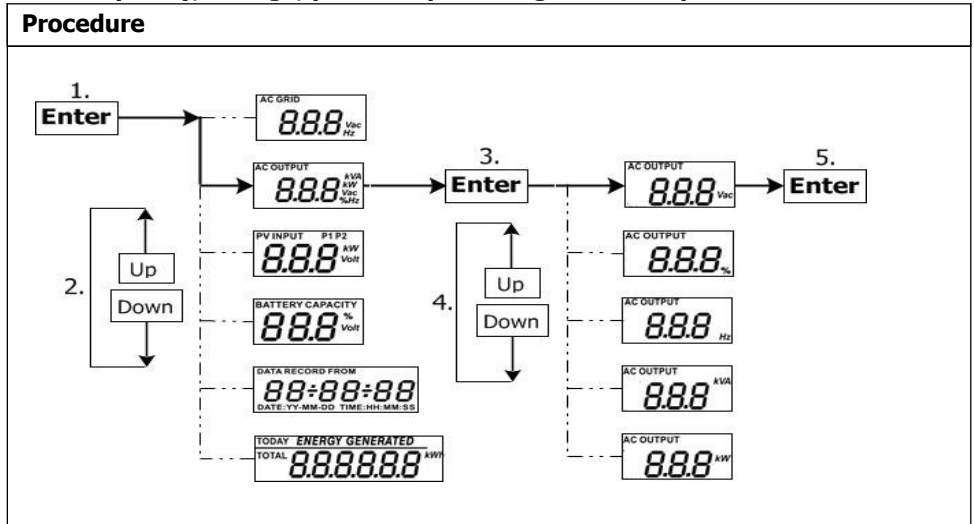

- **Input voltage or power of PV input.**

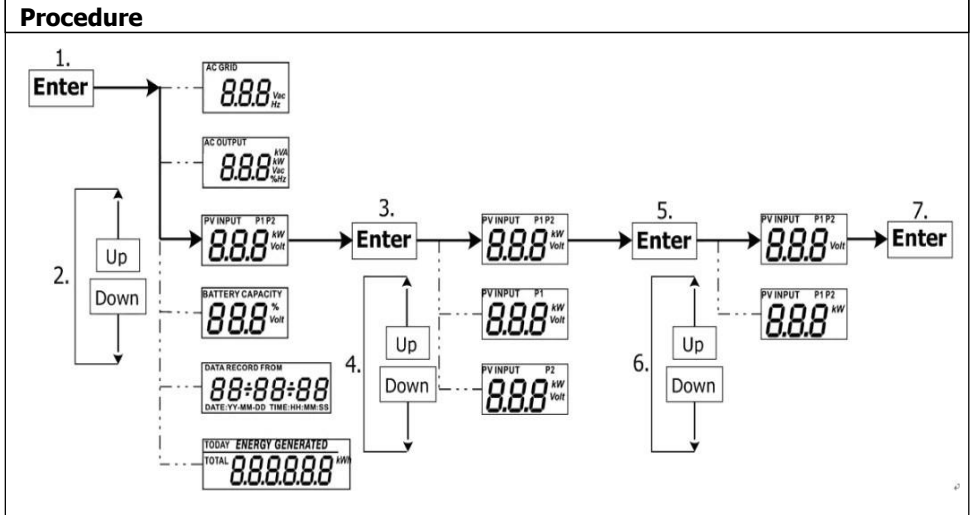

- **Battery voltage or percentage.**

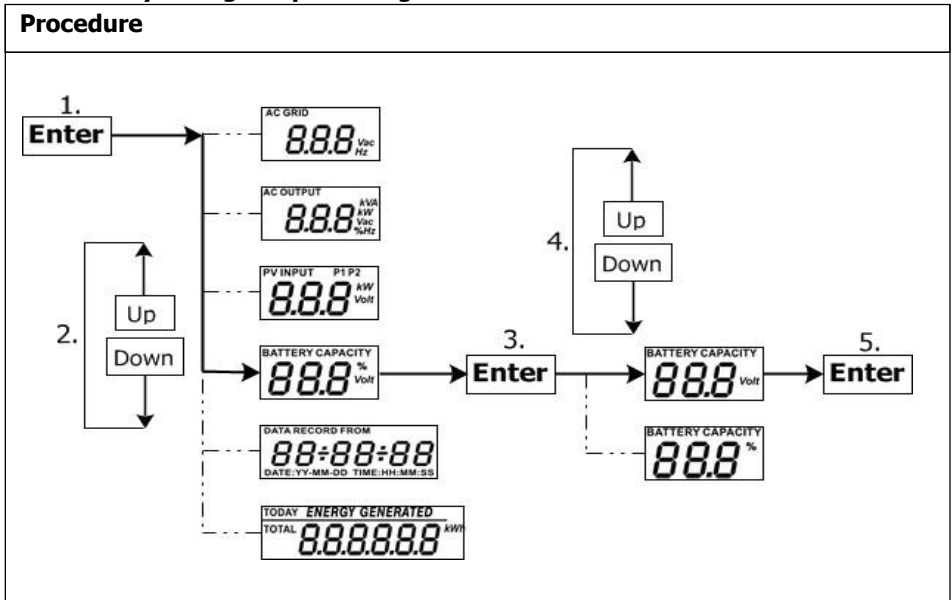

● **Date and time.**

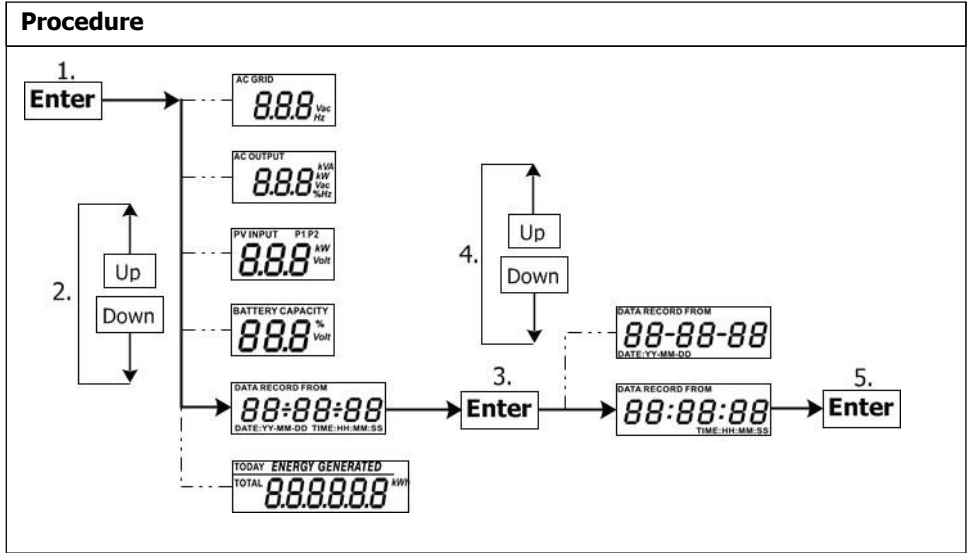

● **Today or total energy generated.**

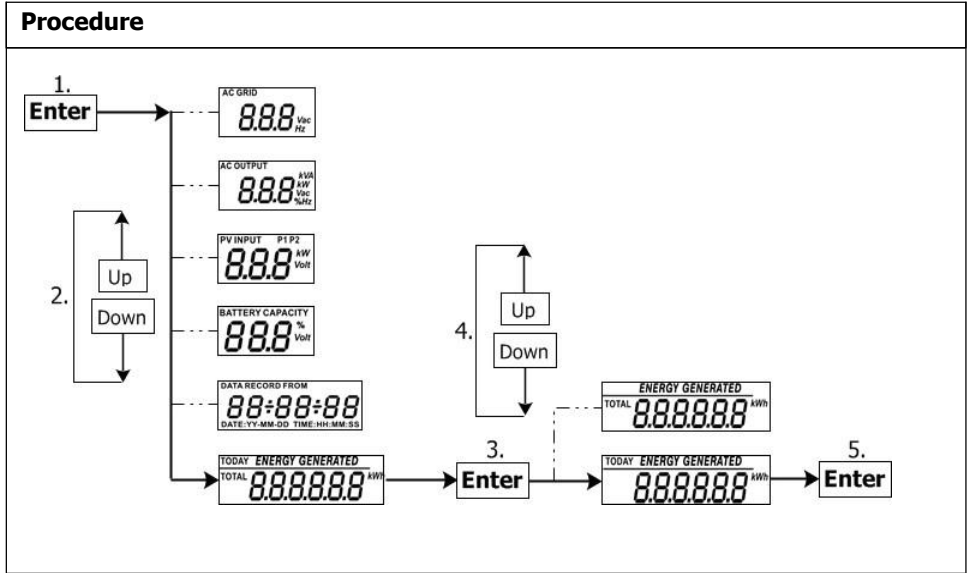

18-5. Operation Mode & Display

Below is only contained LCD display for **grid-tie with backup mode (I)**. If you need to know other operation mode with LCD display, please check with installer.

Inverter mode with grid connected

This inverter is connected to grid and working with DC/INV operation.

LCD Display	Description
<p>The diagram shows two PV panels (P1, P2) connected to an MPPT controller. The MPPT controller outputs DC power to a battery and a DC/DC converter. The DC/DC converter outputs DC power to a DC/AC inverter. The DC/AC inverter outputs AC power to a load and the grid. The grid is shown as a power source.</p>	<p>PV power is sufficient to charge battery, provide power to loads, and then feed in to the grid.</p>
<p>The diagram shows two PV panels (P1, P2) connected to an MPPT controller. The MPPT controller outputs DC power to a battery and a DC/DC converter. The DC/DC converter outputs DC power to a DC/AC inverter. The DC/AC inverter outputs AC power to a load and the grid. The grid is shown as a power source.</p>	<p>PV power is sufficient to charge the battery first. However, remaining PV power is not sufficient to back up the load. Therefore, remaining PV power and the utility are supplying power to the connected load.</p>
<p>The diagram shows two PV panels (P1, P2) connected to an MPPT controller. The MPPT controller outputs DC power to a battery and a DC/DC converter. The DC/DC converter outputs DC power to a DC/AC inverter. The DC/AC inverter outputs AC power to a load and the grid. The grid is shown as a power source.</p>	<p>PV power is generated, but not sufficient enough to charge battery by itself. PV power and the utility are charging battery at the same time. And the utility is also supplying power to the connected load.</p>
<p>The diagram shows two PV panels (P1, P2) connected to an MPPT controller. The MPPT controller outputs DC power to a battery and a DC/DC converter. The DC/DC converter outputs DC power to a DC/AC inverter. The DC/AC inverter outputs AC power to the grid. The grid is shown as a power source.</p>	<p>This inverter is disabled to generate power to the loads via AC output. PV power is sufficient to charge battery first. Remaining PV power will feed in back to grid.</p>

	<p>This inverter is disabled to generate power to the loads via AC output. PV power and utility are charging battery at the same time because of insufficient PV power.</p>
	<p>This inverter is disabled to generate power to the loads via AC output. PV power is feeding power back to the grid.</p>
	<p>PV power is sufficient to provide power to loads and feed power back to the grid.</p>
	<p>PV power and utility are providing power to the connected loads because of insufficient PV power.</p>

Inverter mode without grid connected

This inverter is working with DC/INV operation and not connecting to the grid.

LCD Display	Description
<p>The diagram shows two PV panels (P1 and P2) connected to an MPPT controller. The MPPT controller is shown with a graph of current (I) vs voltage (V). The MPPT controller is connected to a DC/DC converter, which is connected to a BATTERY. The MPPT controller is also connected to a DC/AC converter, which is connected to a LOAD (represented by a light bulb).</p>	<p>PV power is sufficient to charge battery and provide power to the connected loads.</p>
<p>The diagram shows two PV panels (P1 and P2) connected to an MPPT controller. The MPPT controller is shown with a graph of current (I) vs voltage (V). The MPPT controller is connected to a DC/DC converter, which is connected to a BATTERY. The MPPT controller is also connected to a DC/AC converter, which is connected to a LOAD (represented by a light bulb).</p>	<p>PV power is generated, but not sufficient to power loads by itself. PV power and battery are providing power to the connected loads at the same time.</p>
<p>The diagram shows a BATTERY connected to a DC/DC converter, which is connected to a DC/AC converter. The DC/AC converter is connected to a LOAD (represented by a light bulb).</p>	<p>Only battery power is available to provide power to connected loads.</p>



Bypass mode

The inverter is working without DC/INV operation and connecting to the loads.

LCD Display	Description
<p>The diagram shows a UTILITY power source connected to a DC/AC converter. The DC/AC converter is connected to a BATTERY and a LOAD (represented by a light bulb).</p>	<p>Only utility is charging battery and providing power to connected loads.</p>
<p>The diagram shows a UTILITY power source connected to a DC/AC converter. The DC/AC converter is connected to a LOAD (represented by a light bulb).</p>	<p>Only utility is available to provide power to connected loads.</p>

Standby mode :

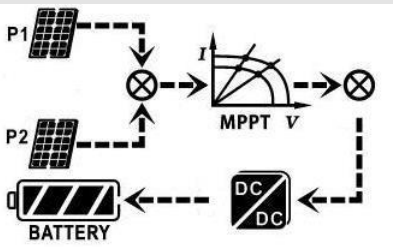
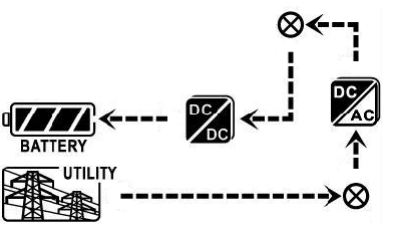
The inverter is working without DC/INV operation and load connected.

LCD Display	Description
	<p>This inverter is disabled on AC output or even AC power output is enabled, but an error occurs on AC output. Only PV power is sufficient to charge battery.</p>
	<p>This inverter is disabled to generate power to the loads via AC output. PV power is not detected or available at this moment. Only utility is available to charge battery.</p>
	<p>If PV, battery or utility icons are flashing, it means they are not within acceptable working range. If they are not displayed, it means they are not detected.</p>

19. Charging Management

Charging Parameter	Default Value	Note
Charging current	60A	It can be adjusted via software from 10Amp to 100Amp.
Floating charging voltage (default)	54.0 Vdc	It can be adjusted via software from 50Vac to 60Vdc.
Max. absorption charging voltage (default)	56.0 Vdc	It can be adjusted via software from 50Vac to 60Vdc.
Battery overcharge protection	62.0 Vdc	
<p>Charging process based on default setting.</p> <p>3 stages:</p> <p>First – max. charging voltage increases to 56V;</p> <p>Second- charging voltage will maintain at 56V until charging current is down to 12 Amp;</p> <p>Third- go to floating charging at 54V.</p>		

This inverter can connect to battery types of sealed lead acid battery, vented battery, gel battery and lithium battery. The detail installation and maintenance explanations of the external battery pack are provided in the manufacturer's external battery pack of manual.

If using sealed lead acid battery, please set up the max. charging current according to below formula:

$$\text{The maximum charging current} = \text{Battery capacity (Ah)} \times 0.2$$

For example, if you are using 300 Ah battery, then, maximum charging current is $300 \times 0.2 = 60$ (A). Please use at least 50Ah battery because the settable minimum value of charging current is 10A. If using AGM/Gel or other types of battery, please consult with installer for the details.

Below is setting screen from software:

Parameters setting

Min. grid-connected voltage:	184 V	Apply	The waiting time before grid-connection:	60 Sec	Apply
Max. grid-connected voltage:	264.5 V	Apply	Max. grid-connected average voltage:	253 V	Apply
Min. grid-connected frequency:	47.48 Hz	Apply	Max. feed-in grid power:	10,000 W	Apply
Max. grid-connected frequency:	51.5 Hz	Apply			

Min. PV input voltage:	300 V	Apply	Floating charging voltage:	54 V	Apply
Max. PV input voltage:	900 V	Apply	Battery cut-off discharging voltage when Grid is available:	48 V	Apply
Min. MPP voltage:	350 V	Apply	Battery re-discharging voltage when Grid is available:	54 V	Apply
Max. MPP voltage:	850 V	Apply	Battery cut-off discharging voltage when Grid is unavailable:	42 V	Apply
Max. charging current:	60 A	Apply	Battery re-discharging voltage when Grid is unavailable:	48 V	Apply
Max. AC charging current:	60 A	Apply	Battery temperature compensation:	0 mV	Apply
Bulk charging voltage(C.V. voltage):	56 V	Apply	Feeding grid power calibration:	0 W	Apply
Start LCD screen-saver after:	None Sec	Apply	Max. battery discharge current in hybrid mode:	10 A	Apply

Mute Buzzer alarm:	<input type="radio"/> Enable <input checked="" type="radio"/> Disable	Apply	Generator as AC source:	<input type="radio"/> Enable <input checked="" type="radio"/> Disable	Apply
Mute the buzzer in the Standby mode:	<input type="radio"/> Enable <input checked="" type="radio"/> Disable	Apply	Activate Li-Fe battery while commissioning:	<input type="radio"/> Yes <input checked="" type="radio"/> No	Apply
Mute alarm in battery mode:	<input type="radio"/> Enable <input checked="" type="radio"/> Disable	Apply	Wide AC input range:	<input type="radio"/> Enable <input checked="" type="radio"/> Disable	Apply

When float charging current is less than X (A) and continued T (Min), then charger off, when battery voltage is less than Y (V), then charger on again.

X:	0 A	T:	60 Min	Y:	53 V	Apply
----	-----	----	--------	----	------	-------

Any schedule change will affect the power generated and shall be conservatively made.

System time: 2014-10-27 14:03:21 Apply

Close

20. Maintenance & Cleaning

Check the following points to ensure proper operation of whole solar system at regular intervals.

- Ensure all connectors of this inverter are cleaned all the time.
- Before cleaning the solar panels, be sure to turn off PV DC breakers.
- Clean the solar panels, during the cool time of the day, whenever it is visibly dirty.
- Periodically inspect the system to make sure that all wires and supports are securely fastened in place.

WARNING: There are no user-replaceable parts inside of the inverter. Do not attempt to service the unit yourself.

Battery Maintenance

- Servicing of batteries should be performed or supervised by personnel knowledgeable about batteries and the required precautions.
- When replacing batteries, replace with the same type and number of batteries or battery packs.
- The following precautions should be observed when working on batteries:
 - a) Remove watches, rings, or other metal objects.
 - b) Use tools with insulated handles.
 - c) Wear rubber gloves and boots.
 - d) Do not lay tools or metal parts on top of batteries.
 - e) Disconnect charging source prior to connecting or disconnecting battery terminals.
 - f) Determine if battery is inadvertently grounded. If inadvertently grounded, remove source from ground. Contact with any part of a grounded battery can result in electrical shock. The likelihood of such shock can be reduced if such grounds are removed during installation and maintenance (applicable to equipment and remote battery supplies not having a grounded supply circuit).

CAUTION: A battery can present a risk of electrical shock and high short-circuit current.

CAUTION: Do not dispose of batteries in a fire. The batteries may explode.

CAUTION: Do not open or mutilate batteries. Released electrolyte is harmful to the skin and eyes. It may be toxic.

21. Trouble Shooting

















When there is no information displayed in the LCD, please check if PV module/battery/grid connection is correctly connected.

NOTE: The warning and fault information can be recorded by remote monitoring software.

20-1. Warning List

There are 17 situations defined as warnings. When a warningsituation occurs, 

icon will flash and  will display warning code. If there are several codes, it will display in sequences. Please contact your installer when you couldn't handle with the warning situations.

Code	Warning Event	Icon (flashing)	Description
01	Line voltage high loss		Grid voltage is too high.
02	Line voltage low loss		Grid voltage is too low.
03	Line frequency high loss		Grid frequency is too high.
04	Line frequency low loss		Grid frequency is too low.
05	Line voltage loss for long time		Grid voltage is higher than 253V.
06	Ground Loss		Ground wire is not detected.
07	Island detect		Island operation is detected.
08	Line waveform loss		The waveform of grid is not suitable for inverter.
10	EPO detected		EPO is open.
11	Overload		Load exceeds rating value.
12	Over temperature		The temperature is too high inside.
13	Batter voltage low		Battery discharges to low alarm point.
14	Battery under-voltage when grid is loss		Battery discharges to shutdown point.
15	Battery open		Battery is unconnected or too low.
16	Battery under-voltage when grid is OK		Battery stops discharging when the grid is OK.
17	Solar over voltage		PV voltage is too high.
18	Inverter cuts off mains output in battery mode		Inverter will cut off mains output and remain power on EMS connector in the battery mode due to low battery.

20-2. Fault Reference Codes

When a fault occurs, the icon **ERROR** will flash as a reminder. See below for fault codes for reference.

Situation			Solution
Fault Code	Fault Event	Possible cause	
01	Bus voltage over	Surge	1. Restart the inverter. 2. If the error message still remains, please contact your installer.
02	BUS voltage under	PV or battery disconnect suddenly	1. Restart the inverter 2. If the error message still remains, please contact your installer.
03	BUS soft start time out	Internal components failed.	Please contact your installer.
04	INV soft start time out	Internal components failed.	Please contact your installer.
05	INV over current	Surge	1. Restart the inverter. 2. If the error message still remains, please contact your installer.
06	Over temperature	Internal temperature is too high.	1. Check the ambient temperature and fans. 2. If the error message still remains, please contact your installer.
07	Relay fault	Internal components failed.	Please contact your installer.
08	CT sensor fault	Internal components failed.	Please contact your installer.
09	Solar input power abnormal	1. Solar input driver damaged. 2. Solar input power is too much when voltage is more than 850V.	1. Please check if solar input voltage is higher than 850V. 2. Please contact your installer.
11	Solar over current	Surge	1. Restart the inverter. 2. If the error message still remains, please contact your installer.

12	GFCI fault	Leakage current exceeds the limit.	1. Check the wire and panels which may cause the leakage.
13	PV ISO fault	The resistance between PV and ground is too low.	2. If the error message still remains, please contact your installer.
14	INV DC current over	Utility fluctuates.	1. Restart the inverter. 2. If the error message still remains, please contact your installer.
16	GFCI sensor fault	GFCI sensor failed.	Please contact your installer.
22	Battery high voltage fault	Battery voltage exceeds the limit.	1. Check the battery voltage. 2. If the error message still remains, please contact your installer.
23	Over load	The inverter is loaded with more than 110% load and time is up.	Reduced the connected load by switching off some equipment.
26	INV short	Output short circuited.	Check if wiring is connected well and remove abnormal load.
27	Fan lock	Fan failed.	Please contact your installer.
32	INV DC voltage over	Load fluctuates	1. Restart the inverter. 2. If the error message still remains, please contact your installer.
33	INV voltage low	Internal components failed.	Please contact your installer.
34	INV voltage high	Internal components failed.	Please contact your installer.
35	Wire connection fault	Internal wires loosen.	Please contact your installer.
36	OP voltage fault	Grid connects to output terminal	Don't connect the grid to the output terminal.

22. Specifications

MODEL	FSP502PV-230H-48
RATED POWER	5,000 W
PV INPUT (DC)	
Maximum DC Power	10,000 W
Nominal DC Voltage	720 Vdc
Maximum DC Voltage	900 Vdc
Working DC Voltage Range	200 Vdc ~ 900 Vdc
Start-up Voltage / Initial Feeding Voltage	250 Vdc / 300 Vdc
MPP Voltage Range	250 Vdc ~ 850 Vdc
Full Load MPP Voltage Range	500 Vdc ~ 850 Vdc
Maximum Input Current	2*10 A
Isc PV (absolute maximum)	25 A
Max. inverter back feed current to the array	0 A
GRID OUTPUT (AC)	
Nominal Output Voltage	230 Vac
Output Voltage Range	184 - 265 Vac
Output Frequency Range	47.5 ~ 51.5 Hz or 59.3~ 60.5Hz
Nominal Output Current	21.8 A per phase
Inrush Current/Duration	25 A / 20ms
Maximum Output Fault Current/Duration	65 A / 1ms
Maximum output Overcurrent Protection	65 A
Power Factor Range	0.9 lead – 0.9 lag
AC INPUT	
AC Start-up Voltage	120-140 Vac
Auto Restart Voltage	180 Vac
Acceptable Input Voltage Range	170 - 280 Vac
Nominal Frequency	50 Hz / 60 Hz
AC Input Power	5000VA/5000W
Maximum AC Input Current	40 A
Inrush Input Current	40 A / 1ms
BATTERY MODE OUTPUT (AC)	
Nominal Output Voltage	230 Vac
Output Frequency	50 Hz / 60 Hz (auto sensing)
Output Waveform	Pure sine wave
Output Power	5000VA/5000W
Efficiency (DC to AC)	91%
BATTERY & CHARGER (Lead-acid/Li-ion)	
DC Voltage Range	40 – 60 Vdc
Nominal DC Voltage	48 Vdc
Maximum Battery Discharging Current	138A
Maximum Charging Current	100 A

GENERAL	
PHYSICAL	
Dimension, D X W X H (mm)	600X460X204.2
Net Weight (kgs)	29
INTERACE	
Communication Port	RS-232/USB
Intelligent Slot	Optional SNMP, Modbus and AS-400 cards available
ENVIRONMENT	
Protective Class	I
Ingress Protection Rating	IP20
Humidity	0 ~ 90% RH (No condensing)
Operating Temperature	-10 to 55°C (Power derating above 50°C)
Altitude	Max. 2000m*

* Power derating 1% every 100m when altitude is over 1000m.

23. Parallel Function

23-1. Introduction

This inverter can be used in parallel with maximum 6 units. The supported maximum output power is 60kW/60kVA.

23-2. Parallel Cable

You will find the following items in the package:



Parallel communication cable



Current sharing cable

23-3. Overview

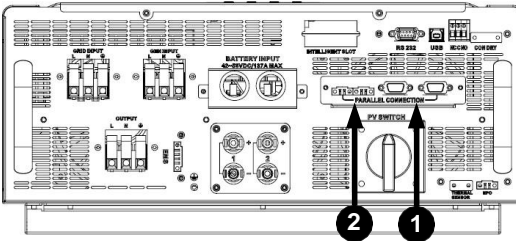

1. Parallel communication port
2. Current sharing port

23-4. Mounting the Unit

When installing multiple units, please follow below chart.

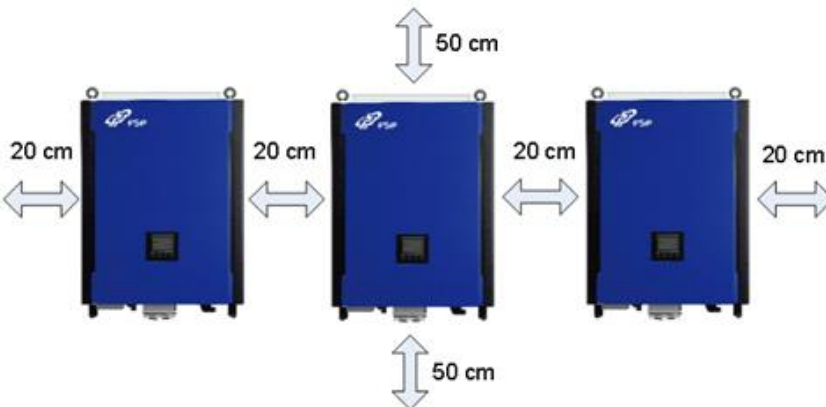

NOTE: For proper air circulation to dissipate heat, it's necessary to allow a clearance of approx. 20 cm to the side and approx. 50 cm above and below the unit. Be sure to install each unit in the same level.

23-5. Wiring Connection

The cable size of each inverter is shown as below:

Ring terminal:

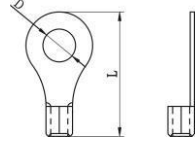

Recommended battery cable and terminal size for each inverter:

Model	Wire Size	Ring Terminal			Torque value
		Cable mm ²	Dimensions		
			D (mm)	L (mm)	
5kW	2	38	8.4	54.2	7~12 Nm

WARNING: Be sure the length of all battery cables is the same. Otherwise, there will be voltage difference between inverter and battery to cause parallel inverters not working.

Recommended AC input and output cable size for each inverter:

Model	AWG no.	Conductor cross-section	Torque
5kW	10~8 AWG	5.5~10 mm ²	1.4~1.6Nm

You need to connect the cables of each inverter together. Take the battery cables for example: You need to use a connector or bus-bar as a joint to connect the battery cables together, and then connect to the battery terminal. The cable size used from joint to battery should be X times cable size in the tables above. "X" indicates the number of inverters connected in parallel.

Regarding cable size of AC input and output, please also follow the same principle.

CAUTION!! Please install the breaker at the battery side. This will ensure the inverter can be securely disconnected during maintenance and fully protected from over current of battery.

Recommended breaker specification of battery for each inverter:

Model	One unit*
5kW	150A/60Vdc

*If you want to use only one breaker at the battery side for the whole system, the rating of the breaker should be X times current of one unit. "X" indicates the number of inverters connected in parallel.

Recommended battery capacity

Inverter parallel numbers	2	3	4	5	6
Battery Capacity	400AH	600AH	800AH	1000AH	1200AH

CAUTION! Please follow the battery charging current and voltage from battery spec to choose the suitable battery. The wrong charging parameters will reduce the battery lifecycle sharply.

Approximate back-up time table

Load (W)	Backup Time @ 48Vdc 800Ah (min)	Backup Time @ 48Vdc 1200Ah (min)
5,000	240	360
10,000	112	168
15,000	60	90
20,000	40	60
25,000	20	30
30,000	13	20

PV Connection

Please refer to user manual of single unit for PV Connection.

CAUTION: Each inverter should connect to PV modules separately.

23-6. Inverters Configuration

No matter how many pieces of inverters installed in parallel, please connect L, N, G terminals of AC input and AC output from each inverter together separately. Connect all battery terminals of each inverter together. Please refer to the following example of 3 units.

Two inverters in parallel:

Power Connection

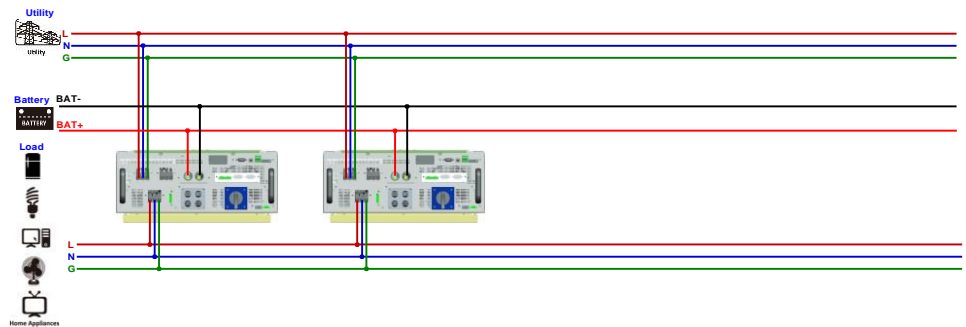

Communication Connection

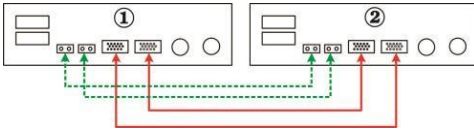

Three inverters in parallel:

Power Connection

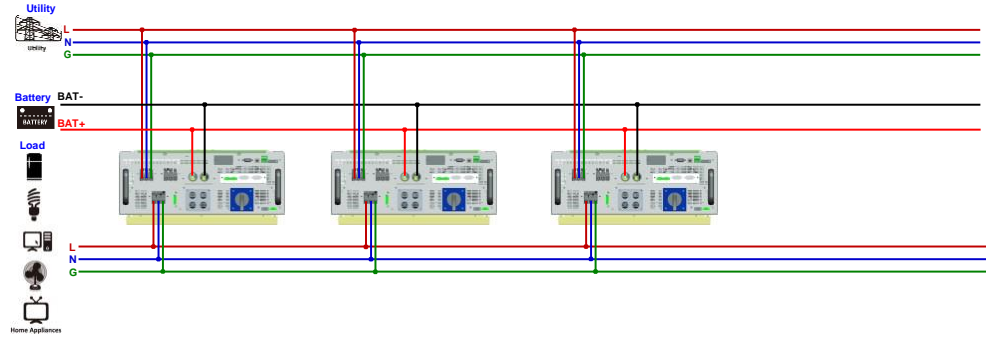

Communication Connection

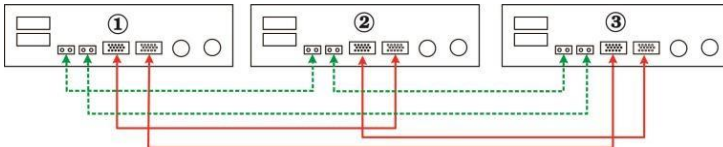

Four inverters in parallel:

Power Connection

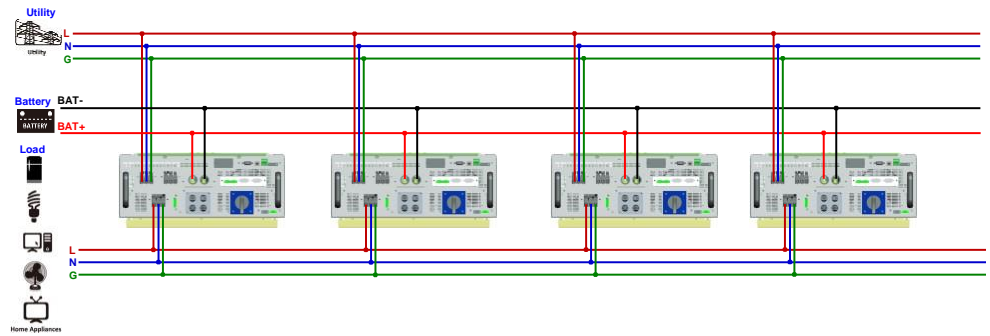

Communication Connection

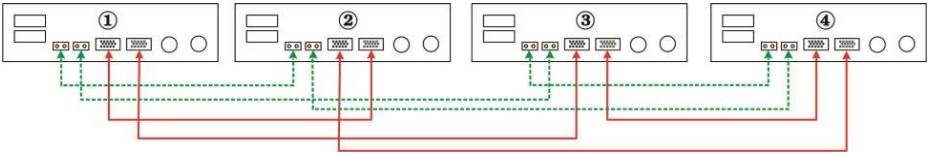

Five inverters in parallel:

Power Connection

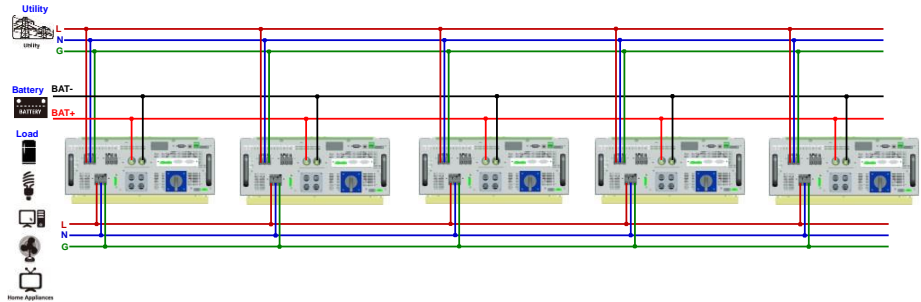

Communication Connection

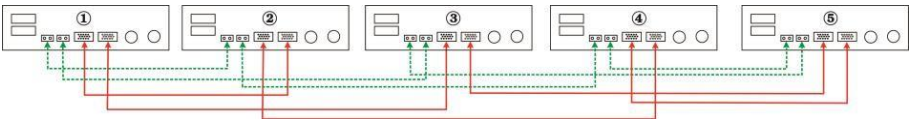

Six inverters in parallel:

Power Connection

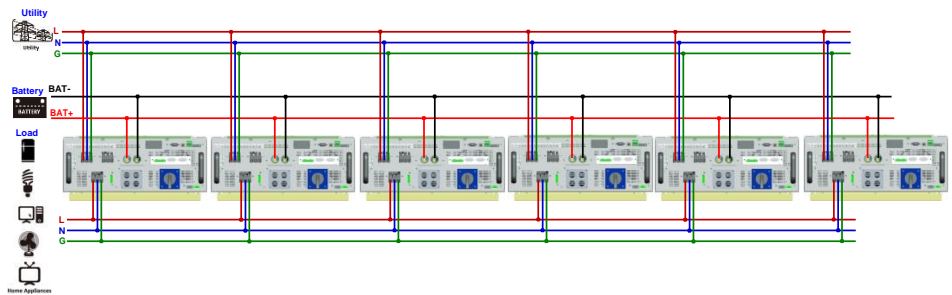

Communication Connection

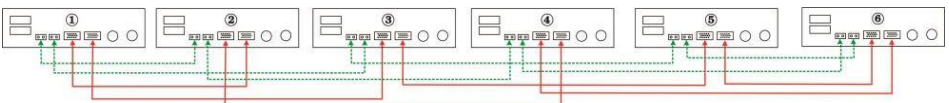

23-7. Setting and LCD Display

Setting Program:

The parallel function setting is only available by Solarpower or Solarpower Pro. Please install the software in your PC first.

For setting, you can set the inverter one by one through RS232 or USB port.

Note: When using serial port (USB or RS-232) for communication, you only can monitor the inverter connected with serial port directly. The other inverters will not be listed in Solarpower software. However, some settings can be applied to all with serial port connection. These kinds of settings are listed as below:

Bulk charging voltage(C.V. voltage) 56.1 V

Floating charging voltage 54.2 V

Battery cut-off discharging voltage when Grid is available 48 V

Battery re-discharging voltage when Grid is available 54.1 V

Battery cut-off discharging voltage when Grid is unavailable 42 V

Battery re-discharging voltage when Grid is unavailable 48 V

Setting

PV energy supply priority setting

Grid-Tie with Backup (1)

Priority: 1st: Battery -> 2nd: Load -> 3rd: Grid

Configuration details

Charging source: None

Not allow to charge battery

Load supply source (PV is available): PV-Grid-Battery

Priority: 1st: PV -> 2nd: Grid -> 3rd: Battery

Load supply source (PV is unavailable): Grid-Battery

Priority: 1st: Grid -> 2nd: Battery

Allow to charge battery

Allow AC to charge battery

Allow to feed-in to the Grid

Allow battery to discharge when PV is available

Allow battery to discharge when PV is unavailable

Allow battery to feed-in to the Grid when PV is available

Allow battery to feed-in to the Grid when PV is unavailable

When battery voltage < 0 V, the AC starts charging

But we suggest you use the SNMP card or Modbus card to combine the system as a centralized monitoring. So you can use "SYNC" option to set all the inverter at the same time.

- Use SNMP card to synchronize the parameters:
Each inverter should have one SNMP card. Make sure all of the SNMP cards are connected to the router as a LAN.

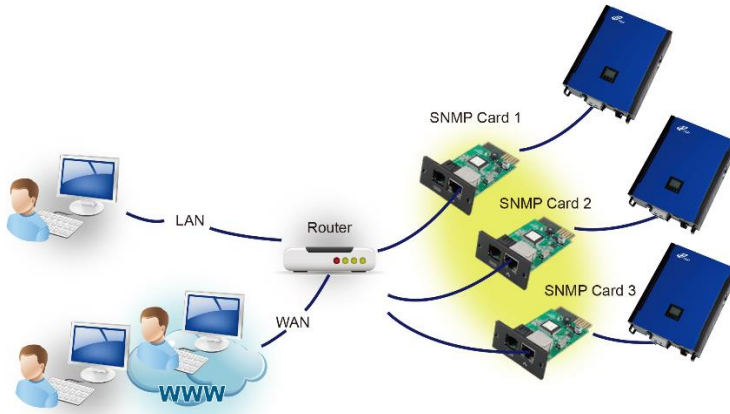

- Use Modbus card to synchronize the parameters:
Each inverter should have one Modbus card. Make sure all of the Modbus cards are connected each other and one of the Modbus cards is connected to the computer by RS-485/RS232 converter.

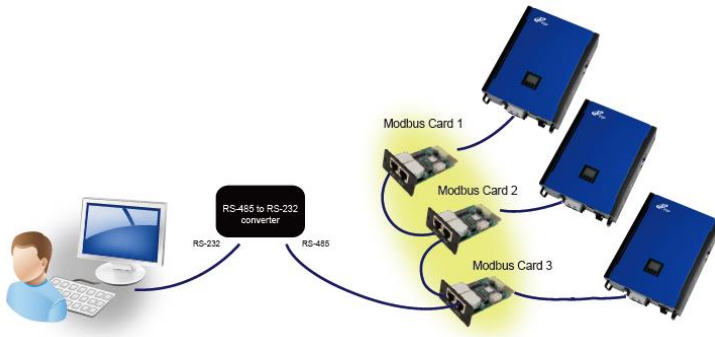

Launch SolarPowerPro in computer and select Device Control >> Parameter Setting >> Parallel output. Two options: Enable or Disable.

If you want to use parallel function, please choose "Enable" and press button. Then, Sync button will be shown is the screen. Please be sure to click "

Sync button before clicking button.

There is a "Sync" button in each parameter setting. When "Sync" is clicked and "Apply" is pressed, this new setting will be applied to all inverters. If not, this setting is only effected in current inverter you choose.

Note: Without centralized monitoring system, "Sync" function is not effective. Then, you have to set up the inverter one by one through serial communication port.

Parallel for output: Enable

The screenshot shows the 'Parameters setting' page of the SolarPower Pro configuration tool. The 'Parallel for output' option is highlighted with a red box and is currently set to 'Enable'. Other settings include:

- Min. grid-connected voltage: 184 V
- Max. grid-connected voltage: 264.5 V
- Min. grid-connected frequency: 47.4 Hz
- Max. grid-connected frequency: 51.5 Hz
- The waiting time before grid-connection: 60 Sec
- Max. grid-connected average voltage: 253 V
- Max. feed-in grid power: 10000 W
- Feed-in power factor: 0.98
- Min. PV input voltage: 300 V
- Max. PV input voltage: 900 V
- Min. MPP voltage: 350 V
- Max. MPP voltage: 800 V
- Max. charging current: 60 A
- Max. AC charging current: 60 A
- Bulk charging voltage(C.V. voltage): 56.1 V
- Floating charging voltage: 54.2 V
- Start LCD screen-saver after: 98 Sec
- Battery cut-off discharging voltage when Grid is available: 48 V
- Battery re-discharging voltage when Grid is available: 54.1 V
- Battery cut-off discharging voltage when Grid is unavailable: 42 V
- Battery re-discharging voltage when Grid is unavailable: 48 V
- Max. battery discharge current in hybrid mode: 300 A
- Battery temperature compensation: 0 mV
- Feeding grid power calibration R: 2 W
- Feeding grid power calibration S: 1 W
- Feeding grid power calibration T: -1 W
- Mute Buzzer alarm: Enable
- Mute the buzzer in the Standby mode: Enable
- Mute alarm in battery mode: Enable
- Parallel for output: **Enable**
- Generator as AC source: Enable
- Activate Li-Fe battery while commissioning: Enable
- Wide AC input range: Enable

When float charging current is less than X (A) and continued T (Min),then charger off; when battery voltage is less than Y (V),then charger on again.
X: 0 A T: 60 Min Y: 53 V

Any schedule change will affect the power generated and shall be conservatively made.
System time: 2015-05-14 09:52:39

Parallel for output: Disable









The screenshot shows the 'Parameters setting' page of the SolarPower Pro configuration tool. The 'Parallel for output' option is highlighted with a red box and is currently set to 'Disable'. Other settings include:

- Min. grid-connected voltage: 184 V
- Max. grid-connected voltage: 264.5 V
- Min. grid-connected frequency: 47.4 Hz
- Max. grid-connected frequency: 51.5 Hz
- The waiting time before grid-connection: 60 Sec
- Max. grid-connected average voltage: 253 V
- Max. feed-in grid power: 10000 W
- Feed-in power factor: 0.98
- Min. PV input voltage: 300 V
- Max. PV input voltage: 900 V
- Min. MPP voltage: 350 V
- Max. MPP voltage: 800 V
- Max. charging current: 60 A
- Max. AC charging current: 60 A
- Bulk charging voltage(C.V. voltage): 56.1 V
- Floating charging voltage: 54.2 V
- Start LCD screen-saver after: 98 Sec
- Battery cut-off discharging voltage when Grid is available: 48 V
- Battery re-discharging voltage when Grid is available: 54.1 V
- Battery cut-off discharging voltage when Grid is unavailable: 42 V
- Battery re-discharging voltage when Grid is unavailable: 48 V
- Max. battery discharge current in hybrid mode: 300 A
- Battery temperature compensation: 0 mV
- Feeding grid power calibration R: 0 W
- Feeding grid power calibration S: 0 W
- Feeding grid power calibration T: 0 W
- Mute Buzzer alarm: Enable
- Mute the buzzer in the Standby mode: Enable
- Mute alarm in battery mode: Enable
- Parallel for output: **Disable**
- Generator as AC source: Enable
- Activate Li-Fe battery while commissioning: Enable
- Wide AC input range: Enable

When float charging current is less than X (A) and continued T (Min),then charger off; when battery voltage is less than Y (V),then charger on again.
X: 0 A T: 60 Min Y: 53 V

Any schedule change will affect the power generated and shall be conservatively made.
System time: 2015-05-14 09:54:14

Fault code display:

Fault Code	Fault Event	Icon on
60	Power feedback protection	
61	Relay board driver loss	
62	Relay board communication loss	
71	Firmware version inconsistent	
72	Current sharing fault	
80	CAN fault	
81	Host loss	
82	Synchronization loss	

23-8. Commissioning

Step 1: Check the following requirements before commissioning:

- Correct wire connection.
- Ensure all breakers in Line wires of load side are open and each Neutral wires of each unit are connected together.

Step 2: Turn on each unit and set "enable parallel for output" on Solarpower or SolarPower Pro. And then shut down all units.

Step 3: Turn on each unit.

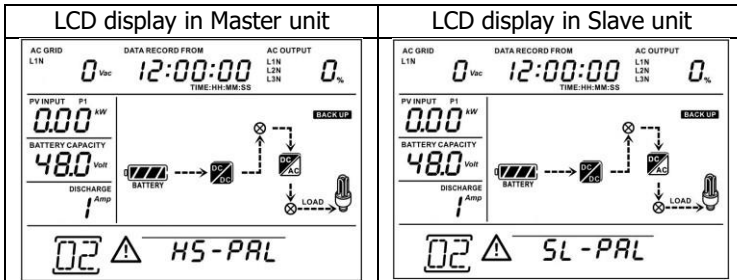

NOTE: Master and slave units are randomly defined. Warning 02 is AC GRID voltage low.

Step 4: Switch on all AC breakers of Line wires in AC input. It's better to have all inverters connect to utility at the same time. If not, it will display fault 82 in following-order inverters. However, these inverters will automatically restart. If detecting AC connection, they will work normally.

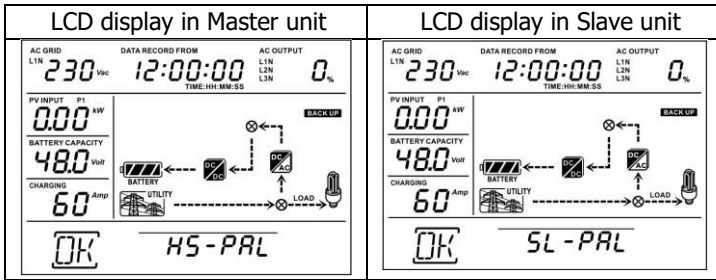

Step 5: If there is no more fault alarm, the parallel system is completely installed.

Step 6: Please switch on all breakers of Line wires in load side. This system will start to provide power to the load.

23-9. Trouble shooting

Situation		Solution
Fault Code	Fault Event Description	
60	Current feedback into the inverter is detected.	<ol style="list-style-type: none"> Restart the inverter. Check if L1/L2/L3/N cables are not connected with wrong sequence in all inverters. Make sure the sharing cables are connected in all inverters. If the problem remains, please contact your installer.
61	Relay board driver loss	<ol style="list-style-type: none"> Disconnect all of power source. Only connect AC input, and press Enter key to let it working in bypass mode. Check if the problem happens again or not, and feed back the result to your installer.
62	Relay board communication loss	
71	The firmware version of each inverter is not the same.	<ol style="list-style-type: none"> Update all inverter firmware to the same version. After updating, if the problem still remains, please contact your installer.
72	The output current of each inverter is different.	<ol style="list-style-type: none"> Check if sharing cables are connected well and restart the inverter. If the problem remains, please contact your installer.
80	CAN data loss	<ol style="list-style-type: none"> Check if communication cables are connected well and restart the inverter. If the problem remains, please contact your installer.
81	Host data loss	
82	Synchronization data loss	



FSP Technology Inc.

No. 22, JianGuo E. Rd., Taoyuan City,
Taiwan, 330

Tel: +886 375 9888

Fax: +886 375 6966

pvinverter.fsp@gmail.com

www.fsp-group.com.tw

Copyright © 2015 FSP Technology Inc.

All rights reserved.